

# NBAD TACKLE BOX

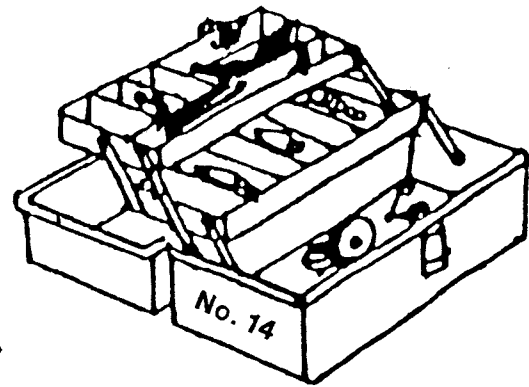

Vol. 14 No. 1

NATIONAL BASS ASSOCIATION OF THE DEAF

March 1992

Every thing is in it or it isn't Bass News

## 17th Annual NBAD Team Tournament Will be Sponsored by Little Rock Bass Anglers of the Deaf, Inc. at Lake Ouachita in Arkansas on June 16, 17, 18, 1992

The 17th Annual NBAD Team Tournament will be held at Lake Ouachita at Mount Ida, Arkansas on June 16, 17, 18, 1992.

The headquarter site will be located at Mountain Harbor Resort about 2 miles off U.S. Highway 270.

The Little Rock Bass Anglers of the Deaf, Inc. will sponsor the tournament under chairmanship of William O. Schwall and his committee.

The first place team winner will be guaranteed to receive \$2,000.00.

This will be the second

time for Arkansas to have a NBAD team tournament. The first one was held at Bull Shoals Lake in 1986 sponsored by Wisconsin Deaf Sports Club.

Mountain Harbor Resort is located about 25 miles west of Hot Springs National Park, Arkansas, just off U.S. Highway 270.

There are attractions, zoo, shopping, history, museums, bus tours, aquarium, view from Mountain Tower and sightseeing adventures.

Don't miss them!

## Presentation of NBAD Patches and History Books at Registration

The presentation of NBAD patches to rookies will be proceeded at the registration instead of General Assembly meeting as in the past.

It would be very convenient for an officer to distribute patches to rookies at registration after they register their entries. They are also required to sign after receiving patches. From the past experience, the officer had to look out for some rookies who did not receive patches at the meeting.

Let's try a new method!

For the first time in history, the entrants will receive NBAD history books at no charge while they register their entries at the registration and they will be required to fill out their present addresses in order to receive newsletters in the fall.

## 483 Anglers Participated in Tournaments Since 1976

The National Bass Association of the Deaf reports that there are 483 participants competed in the annual NBAD team tournaments since 1976. They represented 25 states and Canada.

Here is a record of number of states representing anglers at every tournament from 1976 to 1991 as follows below:

1976 = 5	1984 = 15
1977 = 7	1985 = 14
1978 = 8	1986 = 13
1979 = 9	1987 = 15
1980 = 12	1988 = 15
1981 = 12	1989 = 18
1982 = 9	1990 = 17
1983 = 9	1991 = 21

# NBAD TACKLE BOX

is the official  
publication of

NATIONAL BASS ASSOCIATION  
OF THE DEAF

The publication is  
published twice a  
year in March and  
September.



Founded 1976  
Incorporated 1988

Founder  
Robert Southwell  
Past Founder  
Anthony W. Mowad

1991-1992  
PRESIDENT  
Alan D. Rork

VICE PRESIDENT  
Martin H. Miller

SECRETARY  
Elen Rork Zook

TREASURER  
Jack Stigers

PUBLICITY DIRECTOR  
Joseph O. Broz

LIFETIME EXECUTIVE  
Robert Southwell

EXECUTIVE BOARD  
Charles E. Marsh, Jr.

Copyright 1992

Subscription rate  
is \$5.00 a year.

## NOTES FROM PUBLICITY DIRECTOR

### NBAD Needs Your Help!

Last fall the Publicity Director put on a notice in the NBAD TACKLE BOX newsletter, Vol.13, No.2, September 1991, asking for help to give specific states from where the anglers came. The NBAD did not receive any response at all.

Please, will you fill out the name of state that you know where one or two anglers live and mail it to the Publicity Director or give it to him at the tournament this summer.

<u>1979</u>	<u>State</u>
David Chamagne,	_____
Dell Cholson,	_____
Carlos Flarup,	_____
Luther Green,	_____
Robert Harper,	_____
John Melance,	_____
Mark Philip,	_____
Wayne Schatter,	_____
<u>1987</u>	
S. Brown,	_____
Sonny Johnson,	_____
Andrew Leland,	_____

SCHEDULE OF EVENTS, page 4  
MINUTES OF MEETING, page 7  
FINANCIAL REPORT, page 13  
DEAF NEWS, page 14  
CHALLENGERS, page 15  
DID YOU KNOW? , page 16  
STATISTICAL RECORDS, page 19  
VARIOUS RECORDS, pages 20-41  
FLYERS OF 17th ANNUAL NBAD  
TEAM TOURNAMENT, page 42

## Special Cash Prizes for Setting New Records for 1992

The National Bass Association of the Deaf will award cash prize to a team or angler who breaks one of the current records. If there is no record-breaking this summer, cash prizes will be increased for next year.

Current records are listed as follows below:

#### LUNKER RECORD:

7 lbs. 11 oz. (1976)

#### BASSMASTER RECORD:

44 lbs. 14 oz. (1983)

#### CHAMPIONSHIP TEAM RECORD:

85 lbs. 11 oz. (1983)

Cash prizes are listed for anyone who breaks current records this summer as follows below:

### Cash Prize for New Lunker Record Will be \$610.00

\* \* \* \* \*

### Cash Prize for New Championship Team Record Will be \$410.00

\* \* \* \* \*

### Cash Prize for New Bassmaster Record Will be \$410.00

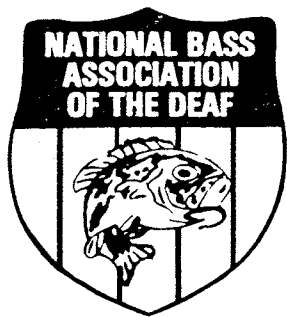

# National Bass Association of the Deaf, Inc.

Founded by Robert Southwell & the Late Anthony Mowad at Toledo Bend, LA in 1976

## NBAD Tournament Calendar

### 1993

1991-1992

#### PRESIDENT

Alan D. Rork  
2011 Ashbourne Road  
Anderson, IN 46011  
TTY 317/649-6309

#### VICE PRESIDENT

Martin H. Miller  
56546 Hollywood Boulevard  
South Bend, IN 46619  
TTY 219/287-3753

#### SECRETARY

Elen Rork Zook  
P.O. Box 44  
Westfield, IN 46074  
TTY 317/773-5442

#### TREASURER

Jack Stigers  
4413 Brenda Drive  
Anderson, IN 46013  
TTY 317/642-5249

#### PUBLICITY DIRECTOR

Joseph O. Broz  
P.O. Box 159  
Onley, VA 23418-0159  
TTY 804/787-8937

#### LIFETIME EXECUTIVE

Robert Southwell  
Rt. 3, Box 183  
Ville Platte, LA 70586  
TTY 318/461-2255

#### EXECUTIVE BOARD

Charles E. Marsh, Jr.  
1063 Ashbury Street  
Olathe, KS 66061  
TTY 913/782-6643

#### 1992 TOURNAMENT GENERAL CHAIRMAN

William Schwall  
20 Kingsport Ct.  
Little Rock, AR 72207  
TTY 501/225-6415

#### 1993 TOURNAMENT GENERAL CHAIRMAN

Winfred Larkin  
9509 Meadowlark Drive  
Indianapolis, IN 46236  
TTY 317/897-3735

1976 Toledo Bend, LA  
1977 Toledo Bend, TX  
1978 Table Rock, MO  
1979 Toledo Bend, TX  
1980 Lake Eufaula, AL  
1981 Lake Livingston, TX  
1982 Lake Eufaula, AL  
1983 Lake Eufaula, OK  
1984 Kentucky Lake, KY  
1985 Toledo Bend, TX  
1986 Bull Shoals, AR  
1987 Kentucky Lake, KY  
1988 Truman Lake, MO  
1989 Lake Barkley, KY  
1990 Sam Rayburn, TX  
1991 Kentucky Lake, KY  
1992 Lake Ouachita, AR  
1993 West Point Lake, GA  
1994 Table Rock, MO  
1995 Lake Okeechobee, FL  
1996 Truman Lake, MO  
1997 Western States Region  
1998 Eastern States Region  
1999 Central States Region

NBAD headquarter site will be held at West Point Lake in Georgia. The tournament will be hosted by Indiana Bass Association of the Deaf.

General Chairman will be Winfred Larkin.

His address is:  
9507 Meadowlark Drive  
Indianapolis, Indiana 46236

### 1994

NBAD headquarter site will be held at the Indian Valeey Resort at Table Rock Reservoir in Missouri. Missouri Deaf Bass Anglers will sponsor 19th annual tournament.

General Chairman will be Edgar J. Long.

His address is:  
2270 Calle Vista Drive  
Florissant, Missouri 63031

### 1995

The 20th Annual NBAD Team Tournament will be held at Lake Okeechobee in Florida on June 11-15, 1995.

The Roland Martin's Marina will be the site for our headquarter during the tournament. The tournament will be hosted by National Bass Association of the Deaf and Wayne Mart of Lakeland, Fla. has been selected as the General Chairman.

His address is:  
7246 Grove Way  
Lakeland, Florida

33809-2605

### 1996

NBAD headquarter site will be held at Bucksaw Point Resort at Harry Truman Reservoir in Missouri. Wisconsin Deaf Anglers will sponsor 21st annual tournament.

General Chairman will be LeRoy D. Elmer.

His address is:  
5206 Piccadilly Drive  
Madison, Wisconsin 53714

### 1997

NBAD headquarter site will be held in Western States region.

### 1998

NBAD headquarter site will be held in Eastern States region.

### 1999

NBAD headquarter site will be held in Central States region.

# 17th Annual National Bass Association of the Deaf Team Tournament

## 1992 Schedule of Events

### JUNE 14, SUNDAY

- 8 A.M. .... NBAD Executive Board Meeting at Office Area
- 1 P.M. to 5 P.M. .... NBAD Registration at Lodge Conference Building
- 7 P.M. .... Council of Representative Meeting at Lodge  
Conference Building

### JUNE 15, MONDAY

- 5 A.M. to 11 A.M. ... Big Lunker Contest
- 8 A.M. to 11 A.M. ... NBAD Registration at Lodge Conference Building
- 1 P.M. .... General Assembly (No fishing)  
Bidding for Tournament Sites  
Presentation of NBAD Patches to Rookies at  
at Lodge Conference Building
- 6 P.M. to 8 P.M. .... Jr. NBAD's Fishing Derby

### JUNE 16, TUESDAY

- 5 A.M. to 3 P.M. .... Team Tournament (1st Day)
- 9 A.M. .... Family Recreation
- 3 P.M. .... Weigh-In
- 7 P.M. .... Announcement of the Winners:  
1-2-3 Places & Lunker  
Social at Lodge Conference Building

### JUNE 17, WEDNESDAY

- 5 A.M. to 3 P.M. .... Team Tournament (2nd Day)
- 9 A.M. .... Family Recreation
- 3 P.M. .... Weigh-In
- 7 P.M. .... Announcement of the Winners:  
1-2-3 Places & Lunker  
Door Prizes at Lodge Conference Building

### JUNE 18, THURSDAY

- 5 A.M. to 3 P.M. .... Team Tournament (Final Day)
- 9 A.M. .... Family Recreation
- 3 P.M. .... Weigh-In
- 7 P.M. .... Announcement of the Winners:  
1-2-3 Places & Lunker  
Announcement of Team Champions, Lunker Champion,  
Sportsmanship & Bassmaster at Lodge Conference  
Building

# List of Affiliated Bass Clubs and Representatives 1991

1. BATON ROUGE DEAF BASS ANGLERS  
Ronald L. Delvisco  
39025 Weiss Road  
Denham Springs, Louisiana 70726
2. MINNESOTA DEAF ANGLERS  
C. Dave Coles  
12113 Edgewood Court  
Champlin, Minnesota 55316
3. NORTH CAROLINA BASS ANGLERS OF THE DEAF  
James Gary Greenwood  
Rt. 4 Box 337  
Newton, North Carolina 28658
4. HEARING-IMPAIRED BASS ANGLERS SOCIETY OF ST. LOUIS  
Raymond McClintock  
1433 Redwood Drive  
St. Louis, Missouri 63366
5. MISSOURI DEAF ANGLERS  
Mack E. Wilson  
10223 St. Arsene Lane  
St. Ann, Missouri 63074
6. EAST TENNESSEE BASS CLUB OF THE DEAF  
Danny K. Cochran  
6442 Beaver Ridge Road  
Knoxville, Tennessee 37931
7. OKLAHOMA BASS ASSOCIATION OF THE DEAF  
Ronald G. Stanford  
Rt. #1 Box 74B  
Calera, Oklahoma 74730
8. WISCONSIN DEAF ANGLERS  
Loren Alderman  
5501 Regis Drive, N.E.  
Fridley, Minnesota 55432
9. LITTLE ROCK BASS ANGLERS OF THE DEAF, INC.  
Rondale J. Ketchum  
P.O. Box 46021  
Little Rock, Arkansas 72214
10. HOUSTON BASS CLUB OF THE DEAF  
Roger Spivey  
4916 Honeysuckle Lane  
Pasadena, Texas 77505
11. COLUMBUS DEAF ANGLERS CLUB  
Jack B. Zeigler  
3694 Quail Hollow Drive  
Columbus, Ohio 43229

# List of Affiliated Bass Clubs and Representatives

## 1991

12. MINNESOTA DEAF SPORTSMAN CLUB  
Jerry D. Drew  
8826 Austin Street, NE.  
Circle Pines, Minnesota 55014
13. INDIANA BASS ASSOCIATION OF THE DEAF  
Connis Collins  
4911 E. 70th Street  
Indianapolis, Indiana 46220
14. DAYTON & INDIANA DEAF ANGLERS CLUB  
Elen R. Zook  
P.O. Box 44  
Westfield, Indiana 46074
15. POLK BASS BUSTERS FOR THE DEAF  
Wayne O. Mart  
7246 Grove Way  
Lakeland, Florida 33809-2605
16. DAYTON DEAF ANGLERS CLUB  
Raymond D. Randall  
1200 N. Circle Drive  
Xenia, Ohio 45385
17. OLATHE BASS CLUB OF THE DEAF  
Wayne W. Neill  
116 S. Emma  
Olathe, Kansas 66061
18. BUFFALO FISHING ASSOCIATION OF THE DEAF  
Wesley A. Parsons  
P.O. Box 574  
Cheektowaga, New York 14225
19. DALLAS BASS ANGLERS OF THE DEAF  
Jesse C. Carrizales  
3728 Modlin  
Mesquite, Texas 75150
20. WISCONSIN DEAF SPORTS CLUB  
George W. Evans  
706 Mayfair Road  
Madison, Wisconsin 53714

# Minutes of NBAD Tournament Meetings

The minutes of Sixteenth Annual National Bass Association Team Tournament at Kentucky Lake in Benton, Kentucky on June 11, 12, 13, 1991.

Meeting: NBAD Executive Boards  
Place: Cabin #23  
Date: June 9, 1991  
Time: 8:15 A. M.

The Executive Boards members were present as follows:

President Alan Rork  
Vice President Martin Miller  
Secretary Alice Rogers  
Treasurer Jack Stigers  
Publicity Director Joseph Broz  
Executive Boards: Robert Southwell  
Charles Marsh  
General Chairman Phil Seim  
1992 General Chairman William Schwall

## General Chairman's Report

Phil Seim, General Chairman of Dayton Deaf Anglers Club explained about \$2,000 guarantee for 1st prize, \$1,000 giveaway for lunker with 100%. About 130 prizes to be drawn and Pull-Pay Raffles- 5-\$100.00 and 10-\$50.00.

## President's Report

1. Vice President has an announcement for Communication and Rules for Guidelines and By-laws at Representation meeting.
2. Look out for Constitution (Article III and Section 3 for Memberships) and Tournament Rules (#3 Participants and Eligibility). The rules are conflict.
3. Untable to vote for Lake Okeechobee, Florida and Kentucky Lake, Tennessee for 20th Annual NBAD Team Tournament in 1995.
4. Does N.B.A.D. invite Water Patrol to provide the water safety and rules in General Assembly every year?
5. NBAD will present the Hall of Fame Awards every year.
6. NBAD has new awards for 10 years or more (with/without 10 straight years) and 15 straight years.
7. Registered Agent is not required for Officer, but resident agent is from the state of Indiana for Non-Profit Corporation (Incorporation).
8. Discuss about weight scale with readout remote display.

9. Robert Southwell is a nomination Chairman.

10. Anglers, the Participants of Bass Club, required to be two successive years organized priority to bid the NBAD tournament.

Recommendation by Board of Directors to have to be awarded Hall of Fame Annual meeting. Passed.

Recommendation by Board of Directors to delete the minimum (8) members affiliate and require 8 members for bidding. Passed 2/3.

Suggest that the Host Club to get 27 plaques and NBAD get 2 plaques. Passed.

Adjourned at 11:45 A.M.

## **Council of Representatives**

The NBAD Council of Representatives session began at 7:20 P.M. at the Shelter on June 9, 1991.

President Alan Rork  
Vice President Martin Miller  
Secretary Alice Rogers  
Treasurer Jack Stigers  
Publicity Director Joseph Broz  
Executive Boards: Robert Southwell  
Charles Marsh  
General Chairman Phil Seim  
1992 General Chairman William Schwall

The minutes of June 10, 11, 1990 is read in good standing.

Treasurer's Report were audited by 3 out of states. Wesley Parsons (George Evans) accepted the Auditor's Committee. Passed.

### **President's Report**

1. Vice President has an announcement for communication and Rules for Guideline and By-Laws at representation meeting.
2. Look out for Constituion (Article III and Section 3 for Membership) and Tournament Rules (#3 Participants and Eligibility). The rules are conflict.
3. Untable to vote for Lake Okeechobee, Florida and Kentucky Lake, Tennessee for 20th Annual NBAD Team Tour-



ament in 1995.

4. Does NBAD invite Water Patrol to provide the water safety and rules in General Assembly every year?
5. NBAD will present the Hall of Fame Awards every year.
6. NBAD has new awards for 10 years or more (with/without 10 straight years) and 15 straight years.
7. Discuss about weight scale with readout remote display.
8. Registered Agent is not required for Officer, but resident agent is from the state of Indiana for Non-Profit Corporation (Incorporation).
9. Robert Southwell is a Nominative Chairman.
10. Anglers, the participants of Bass Club, required to be two successive years organized priority to bid the NBAD tournament.

Vice President Martin Miller explained that he would rather for all Affiliated Clubs to send the motions and Quotas within 90 days instead 60 days.

Phil Seim, General Chairman explained that there will be the inspectors at the end of the dock at 4:00 A.M. After the Boat inspector. Alan Rork will give you a go signal to leave the dock. The inspector will check your boat for all safety that you must have. 1. Kill switch, 2. Life jackets, 3. Fire extinguisher, 4. Horn or Whistle, 5. Safety Cushions, 6. First Aid, 7. State Fishing License.

### **Unfinished Business**

Martin Miller (Dave Coles) motioned to untable the 2 lakes. Robert Southwell (Charles Marsh) amends to bring to General Assembly. Passed. 28-0.

### **Motions & Proposals**

Motion I. Minnesota Deaf Anglers made a motion that a penalty of two ounces (oz.) will be deducted for each fish that is weigh in. No bonus ounces will be given for live fish. Ronald Stanford second. Passed. Vote on Main Motion. Passed.

Motion II. Minnesota Deaf Anglers moved that no net allowed during the tournament. No one second.

Motion III. Minnesota Deaf Anglers made a motion that Host Committee are responsible for weigh in. The reason is contestants could not wait for N.B.A.D. Officers to come to

weigh in. Host Committee have a time, but Vice President must be there on time for weighing. No one second.

Motion IV. Robert Southwell, Co-Founder moved that we should have a chairman of the 1995 National Bass Association of the Deaf Team Tournament. Rondale Ketchum second. Raymond Randall (Wesley Parsons) motioned to close with discussion. Vote on close with discussion. Passed. Martin Miller (Danny Cochran) amends to tomorrow General Assembly. Passed.

Motion V. Robert Southwell, Co-Founder moved to have a raffle ticket chairman for 1995 National Bass Association of the Deaf Team Tournament. Raymond Randall second. William Schwall (Juan Carrizales) amends to change to 1995 chairman donation. Passed. Vote on Main motion. Passed.

Motion VI. Robert Southwell, Co-Founder moved that when weighing in a one pound penalty will be assessed on each floating fish. Withdraw.

Motion VII. Robert Southwell, Co-Founder made a proposal to establish a scholarship for the children of N.B.A.D. members of 3 years or longer. Dave Coles second. Failed.

Motion VIII. Little Rock Bass Anglers of the Deaf, Inc. made a motion the Host shall pay the lodging expenses in half for the officers of N.B.A.D. instead of the full single rate. Ronald Stanford second. Passed by 2/3.

Motion IX. Olathe Bass Club of the Deaf made a proposal that the minimum length shall be 15 inches. Effective in 1992 to be counted during N.B.A.D. Team Tournament for 3 days. Out of order.

Motion X. Missouri Deaf Bass Anglers made a proposal that Quota \$2.00 fee shall change to Registration fee. Out of order.

Motion XI. Missouri Deaf Bass Anglers made a proposal that we shall have 5 miles radius from the marina. William Schwall second. Elen Zook (Loren Alderman) amends to maximum 5 miles marina. Vote on Elen Zook's amends. Passed. Vote on Main motion. Passed.

Motion XII. Randy Poteat made a motion to request that N.B.A.D. to please enforce its own rule of starting at 5:00 A.M. on the button and check in at 3:00 P.M. Regardless of the weather. No one second.

Motion XIII. Dayton Deaf Anglers Club proposed that anyone who pays entry fee and does not show up, will have their program book and grab gift, mailed to him or her. Ronald Stanford second. Passed.

Motion XIV. Dayton Deaf Anglers Club made a proposal to have winners Plaque - only the Champion's name, date and year on name plate. N.B.A.D. will bring back the winners Plaque every year for display. Danny Cochran second. Passed.

Motion XV. Dayton Deaf Anglers Club made a proposal to have non-participants pay \$1.00 for registration card, the reason is that they will know who they are and will be color coded from fishermen registrations which are white. Out of order.

Vice President Martin H. Miller ask you to revise items.

The meeting of June 20, 1982 Johnny Scott (Tom Rogers) moved that the host club buy 2 golf shirts with the words on the back "N.B.A.D. Team Championship" starting 1983. Passed.

Change from two golf shirts to two baseball caps.  
No one second.

The meeting of June 20, 1982 Neal Barker (Homer West) moved that the N.B.A.D. pay \$200.00 with a plaque to a winner who breaks the N.B.A.D. lunger record starting in 1983. Passed.

Kill the motion because there is a special prize for that. Withdraw.

The meeting of June 19, 1983 Tom Eades moved that N.B.A.D. Tacklebox issues be sent 30 days before tourney. Passed.

change from 30 days to 90 days before the tourney because of short time. Ronald Stanford second. Passed.

The meeting of June 19, 1983 Bob Alcorn (Tom Eades) moved that the host and N.B.A.D. be not responsible for pairing the partners. Passed.

Kill the motion because it shows lack of sportsmanship and fellowship. Withdraw.

The Hall of Fame (2) Fisherman with 10 straight years of attendance.

Omit the words of straight and years, Put times in because of too far from East to West states. Wesley Parsons second. Alan Rork (Loren Alderman) amends to add 2 awards. Passed.

Ajourned at 9:25 P.M.

## General Assembly

President Alan Rork called the General Assembly session to order at 1:10 P.M.

Safety Patrol was introduced to all the Anglers and fans by Connie Brumbaugh, a interpreter. He explained about safety boat and water and etc.

Mack Wilson (Dave Coles) motioned to untable the 2  
lakes Passed. Florida 51-2.

William Schwall (Ronnie Delvisco) motioned Wayne Mart as  
General Chairman for 1995. Passed. I, Alice Rogers cast the  
ballot Wayne Mart as General Chairman for 1995.

No biddings.

### **Election of Officers**

Mack Wilson (Wayne Mart) acclamation Alan Rork as  
President. Passed.

Elen Zook (Mack Wilson) acclamation Jack Stigers as  
Treasurer. Passed.

Ed. Long (Mack Wilson) acclamation Joseph Broz as  
Publicity Director. Passed.

### **New Officers**

President-----Alan Rork

Vice President-----Martin Miller

Secretary-----Elen Zook

Treasurer-----Jack Stigers

Publicity Director--Joseph Broz

Adjourned at 4:20 P.M.

# NBAD Financial Report

Financial Report of the 16th Annual National Bass Association  
of the Deaf Team Tournament at Sportsman's Lodge, Kentucky Lake  
on June 11, 12, & 13, 1991.

## RECEIPTS

Balance brought forward	\$ 7,431.77
Affiliation Membership Dues	
20 @ \$25.00	\$ 500.00
Association Membership Dues	
14 @ \$10.00	140.00
Quota Fee 1990 24 @ \$2.00	48.00
Quota Fee 1991 429 @ \$2.00	858.00
Interest	534.73
2 Video tapes @ \$10.00	20.00
NBAD sales	134.00
National Fraternal Society of the Deaf	160.31
Donation by Hollis Warmack, Jr.	40.00
Bank Charge Refund	5.00
112 Entry Fee @ \$50.00	5,600.00
46 Late Entry Fee @ \$60.00	2,760.00
	10,800.04
<b>TOTAL</b>	<b>\$ 18,231.81</b>

## DISBURSEMENTS

Secy of State	\$ 10.00
1990 Minutes/Postage	94.00
Indiana Bass Assn, of the Deaf (NFSD Commission)	56.11
Indiana Dept. of Revenue	44.68
Tax Service	35.00
Tackle Box Newsletter/Postage	475.45
Affiliation & Entry Newsletter	84.90
Bassmaster/Sportsmanship Trophies	20.00
Laws/Rules	258.11
Letterheads	70.00
Deaf Mosaic	210.00
2 Executive Free Entry Fees @ \$50.00	100.00
1 Free Entry Fee - Gene Amons	40.00
Award of Hall	50.59
D.D.A.C Host	790.00
Daily Prizes	600.00
Prize Fees	5,530.00
Bassmaster Prize	158.00
Lunker Prize	158.00
NBAD foods	58.76
Short Balance	59.94
Officers Expense;	
Alan Rork, President	153.09
Martin Miller, Vice President	34.38
Alice Rogers, Secretary	12.75
Jack Stigers, Treasurer	45.81
Joseph O. Broz, Pubicity Director	103.08
	\$ 9,252.65
<b>TOTAL</b>	<b>\$ 9,252.65</b>

## RECAPITULATION

Receipts total	\$ 18,231.81
Disbursement total	9,252.65
<b>Net Balance</b>	<b>\$ 8,979.16</b>

## FUNDS

NBAD General Fund	\$ 2,930.06
Little Rock Bass Anglers of the Deaf (1992)	330.00
Indiana Bass Association of the Deaf (1993)	600.00
Missouri Bass Deaf Anglers (1994)	600.00
NBAD Annual Fund (1995)	1,369.10
Wisconsin Deaf Anglers (1996)	1,500.00
Lunker Record ( 7 lbs & 11 oz )	610.00
Bassmaster Record ( 44 lbs & 14 oz )	410.00
Team Champion ( 85 lbs & 14 oz )	410.00
3 Entry Fees	120.00
2 Executive Entry Fees	100.00
	100.00
<b>TOTAL</b>	<b>\$ 8,979.16</b>

Submitted by Jack Stigers, Treasurer.



## ***It's another world, they're talking with their hands and fingers***

Photo/Article by Art Evans

Sunday, August 4th, friends from Olathe, Kansas had a cookout among the shade trees at the cabin of Buddy Willoughy, fisherman and sportsman, in the hills of Western Bates on the Missouri-Kansas State Line at Worland, 30 miles from Adrian.

For Journal readers, this group is "talking" for this picture. They were talking about this coal mining area, fishing and hunting.

Shown here left to right is Richard Stoecklein, a janitor at Olathe's Kansas State School for the Deaf, a friend who was Buddy's fishing pal 30 years

ago; Kester Marsh - a student at Johnson County Community College who speaks English and signs to his mother, Kathy Marsh, a teacher's aide at KSD and Olathe Public Schools. Kester's father, Charles, fifth from the left is a Physical Education instructor at KSD. He is signing to his friend Neal Barker, layout man for Quality Wood Products of Kansas City, Mo. Thirty-five years ago Neal lost a thumb and finger in a table saw accident. Signers need all their fingers to communicate.

Kester's father was born deaf. His

mother had a fever when a small baby and lost her hearing.

At Olathe there is a bass fishing group that holds tournaments each month at some lake.

Persons who have a hearing challenge can use a small device with a small keyboard with a screen and dial a telephone operator, a relay operator, to assist in sending a message from a hearing person. Kansas is the first state to have such a service. Missouri has had it about a year.

These visitors enjoyed being in Bates County and meeting Buddy Willoughy's neighbors and friends.



Two big bass from Lake Castaic: Mike Arujo's 21 lb 12 oz catch (left) and Bob Crupi's 22.01 lb lunker.

## Challengers Keep Inching Closer To 60-Year-Old Largemouth Record

California's Lake Castaic just keeps popping out bigger and bigger largemouth bass. No one could argue if the city fathers placed a "Bass Capital of the World" sign at Castaic's town limits.

In a seven-day span last March, Mike Arujo caught a 21 lb 12 oz largemouth and Bob Crupi captured and released a lunker weighing 22.01 lb while fishing on the famed bass lake.

These are the two biggest largemouth bass catches ever submitted to IGFA for line class recognition. George W. Perry's 22 lb 4 oz all-tackle record bass taken from Georgia's Montgomery Lake in 1932 was given recognition by *Field & Stream* magazine before the publication turned its freshwater records over to IGFA.

Arujo's bass caught on March 5, has been submitted in the 12-lb line class category.

Crupi's monster fish, the first largemouth documented over 22 lb in nearly 60 years, was hooked on March 12. It has been submitted for the 20-lb line class record, currently held by Dan Kadota, and also taken from Lake Castaic.

A nearby fisherman Jeff Ackerman not only saw Crupi boat the bass; he also saw him return and release it a couple of hours later near the very spot he caught it.

"It was a chance of a lifetime for me to see that," said Ackerman, a movie set prop man in Hollywood. "I didn't realize how big it was until he came back. Most guys, after weighing it and realizing it was a record, would have kept it and

mounted it. I thought it was great that he came back and released it."

To anyone's knowledge, Crupi's fish is the first over 22 pounds to have its picture taken. Perry never photographed his fish; he had it for dinner.

Crupi weighed and measured his bass in front of witnesses Veronica DeGeorge and Noelle Riach at Castaic Hardware, and had it photographed by the owner of the local Radio Shack store. Crupi's fish was not approved as the California state record (granted to Arujo) because it was not examined by a Department of Fish and Game biologist.

Arujo was critical of the circumstances surrounding Crupi's catch.

"I don't know why anyone who caught a fish that big would release it," said Arujo of Santa Monica.

Crupi, a Los Angeles Police Department motorcycle cop, said he used to mount his big catches before he became preservation-minded as he is now. Crupi has many mounts of big fish, including four different versions of a 21 lb largemouth he caught in March 1990 for the IGFA 12-lb line class record. He claims that is enough for his wall. He has been practicing catch-and-release since the early 1980s, he said.

"Before I even weighed that fish, I knew that as healthy as she was, I was going to release her. I felt that with all the big fish coming out of Castaic (four over 21 lb in the last year), if we don't keep this fish in with the gene pool of these other world-class fish, then we'll be in

trouble."

Kadota, the king of Lake Castaic bass fishermen with 92 over 10 pounds, said he knows Crupi, trusts him completely, and would never doubt his integrity.

Arujo, 31, is a big game fishing enthusiast who works summers on a sports boat out of Santa Monica. He bass fishes with artificial lures while Crupi uses live crawdads for bait.

Arujo's bass measured 28 1/2 inches long and 26 1/2 in girth compared to Crupi's bass that was 29 1/2 inches long and 27 1/2 inches in girth.

Crupi, who can see part of the lake from his home a mile away, said, "The next all-tackle world record largemouth is going to come from Lake Castaic. And, I know where she is."

IGFA has begun investigating and processing the two record applications and will render a decision within 90 days. Three of the current line class records for largemouth bass are held by Lake Castaic fishermen. The last four largemouth winners in IGFA's annual fishing contest came from the same lake. (Source: IGFA files and *San Diego Tribune*.)

THE INTERNATIONAL ANGLER

INTERNATIONAL GAME FISH ASSOCIATION  
3000 EAST LAS OLAS BOULEVARD  
FORT LAUDERDALE, FLORIDA 33316, U.S.A.

## Did You Know?

- Percentage of wetlands lost in past 200 years in continental U.S.: 53%
- Percentage of wetlands lost in past 200 years in Alaska: under 1%
- On average, the continental U.S. has lost over 60 acres of wetlands every hour between the 1780's and the 1980's
- California has lost 91% of its original wetlands
- Decline in Chesapeake Bay in past 30 years in landings of striped bass: 70%
- Decline in Chesapeake Bay in past 30 years in landings of hickory shad: 96%
- Decline in Chesapeake Bay in past 30 years in landings of river herring: 92%
- In 1989 recreational billfish hooked per hour of trolling in the northern Gulf of Mexico was the lowest in history of a 19-year study
- Hours of trolling required to hook 1 blue marlin: 43
- Hours of trolling required to hook 1 white marlin: 91
- Hours of trolling required to hook 1 sailfish: 330
- Amount of bycatch discarded by shrimp trawlers annually in Bay of Bengal: 800 million pounds
- Number of pounds of bycatch discarded for each pound of shrimp by small trawlers in West Bengal: 23 pounds
- In 1989, U.S. commercial fishermen landed 2.3 billion pounds of fish and shellfish for industrial use (including bait and animal food)
- Chances of U.S. citizens being killed by a shark: 1 in 300 million
- Chances of U.S. citizens being killed by lightning: 1 in 1.9 million
- Number of sailfish released by the two last place teams in the 1991 Costa Rica International Billfish Tournament — 36.
- U.S. recreational angler catch in the Atlantic in 1990 — 318 million pounds. Expenditures by U.S. recreational anglers in 1990 — \$7.2 billion. Percentage of the recreational catch released — 55 percent.
- U.S. commercial landings in 1990 — 9.7 billion pounds. Value of U.S. commercial landings in 1990 — \$3.6 billion.
- Number of \$50 tarpon tags (required to boat a tarpon) sold in Florida in 1990 — 659. Number of tarpon tags reported used on boated tarpon — 172.
- Longest cast certified by the International Casting Federation — 574 ft. 2 in. Longest cast with fly rod — 257 ft. 2 in.
- Most largemouth bass caught in season — 3,001 (caught in 77 days of fishing by David Romeo in 1984).
- The largest amount of money ever received for catching a world record fish was \$250,000 paid to Al McReynolds for his all-tackle record striped bass of 78 lb 8 oz in 1983. Abu Garcia paid the money as a contest prize.
- Annual U.S. driftnet quota for swordfish for 1991 — 81,570 lb. Estimated driftnet landings of swordfish as of July 3, 1991 — 150,000 lb.
- Number of Pacific salmon, steelhead and trout stocks in U.S. considered to be at high risk of extinction — 101. Number of these stocks listed as threatened under Endangered Species Act — 1.
- One live bait farm in Mississippi needs 45 trucks, 18 tractors and two airplanes to process 300 million minnows per year.
- Number of fishing tournaments held annually in Canada and the U.S. — 31,000. Most common freshwater tournament target — bass. Most common saltwater tournament target — billfish.
- Number of species available for new 20-lb tippet record categories — 158. Number of species submitted for 20-lb tippet records through August — 19. Vacant 20-lb tippet records waiting to be filled — 139.
- Squid have been documented up to 55 feet long and 4,000 lb.
- U.S. minimum size limit on cobia is 37 inches while the minimum size limit on swordfish is 31 inches.
- IGFA world records set in 130-lb line class in 1990 — 2. World records set in 4-lb class — 39.
- U.S. longline quota for bluefin tuna for 1991 — 145 tons. Reported U.S. longline landings of bluefin tuna through June 20 — 193 tons.
- Estimate of sea birds destroyed by Exxon Valdez oil spill — 390,000.
- If the 633,772 boats registered in the state of Florida were placed end to end, they would stretch 2,055 miles.
- Iceland leads the world in per capita consumption of fish with 195 lb (88.4 kg) per year.
- Total number of fish caught by recreational anglers in the Gulf of Mexico in 1989 — 99.5 million. Number of fish discarded by offshore shrimpers in the Gulf of Mexico in 1989 — 9.6 billion.
- Number of marine mammal species in southwest U.S. — 18. Number of endangered or threatened mammal species in southwest U.S. — 15.
- An electric eel can generate 550 volts of electricity.
- Number of marine fishery stocks, species or species groups considered by the U.S. government to be over exploited: 14
- Number of over exploited stocks that would require five to ten years to recover if fishing was stopped completely: 10
- Number of over exploited stocks in which fishing continues: 8
- Amount of baitfish (Pomfret) discarded annually by the north Pacific driftnet fleet targeting squid: 100,000 tons
- Florida leads the U.S. in most species for which state records are maintained: 73 saltwater and 25 freshwater species
- The first broadbill swordfish caught on rod and reel was landed in California in 1913. It was caught using a bait rigged from a kite and weighed 355 pounds
- Average annual consumption of fish per person in the U.S.: 15 pounds
- Average annual consumption of fish per person in Japan: 153 pounds
- Average price per pound of bluefin tuna in 1971: 8 cents
- Median income in U.S. of households purchasing fishing equipment: \$37,916
- Median income in U.S. of households purchasing golf equipment: \$48,401
- Median income in U.S. of households purchasing ski equipment: \$52,725
- Percentage of U.S. households with anglers: 36 percent

(Continued)



## Did You Know?

- Number of U.S. federal agencies with jurisdiction over fisheries: 37
- Number of years taken to enact the billfish management plan: 9
- Total number of world records maintained by IGFA: 3,237
- Number of world records approved by IGFA in 1989: 339
- The heaviest IGFA record fish on fly rod: 356 lb jewfish caught by Bart Froth in 1967
- 1988 Atlantic sailfish and marlin landings led by Taiwan: 2,354,000 lb; No. 2 Japan 2,299,000 lb
- Total U.S. marine recreational fishermen: 17,000,000
- Total U.S. recreational catch in 1989: 469.2 million lb
- Total U.S. recreational expenditures for fishing: \$7.2 billion
- Recreational expenditure per pound: \$15.35
- Total U.S. marine commercial fishermen: 273,700
- Total U.S. commercial landings 1989: 10.7 billion lb
- Total value of commercial landings 1989: \$3.6 billion
- Value of commercial catch per pound: 33 cents
- The number of blue sharks observed caught by the Japanese squid drift net fishery from June to December, 1989: 58,000
- Number of seabirds observed caught: 9,170
- Number of dolphins observed caught: 914
- Number of pomfret (baltfish) observed caught: 1,433,496
- Percentage of Japanese drift net fishery effort covered by official observers: 4%
- U.S. fishing licenses purchased in 1989: 30,302,244
- State with highest number of license holders: California, 2,164,120
- Second highest: Texas 1,934,563
- Least number of licenses: Hawaii, 9,282
- Total number of fishing days by U.S. anglers projected for 1990: 1,036,540,476
- The longest standing all-tackle world record for a gamefish is held by Dr. C.C. Abbot's 4 lb 3 oz yellow perch caught at Bordentown, New Jersey, U.S.A. in May, 1865.
- In 1988 over 70,000 juvenile swordfish under 40 pounds were brought to market by U.S. commercial fishermen. Female swordfish reach reproductive maturity at about 150 pounds.
- Eight of the 10 largest largemouth bass on record came from California and four of them were caught in Lake Castaic in the past 15 months
- The oldest existing fishing club is The Ellem Fishing Club formed in Scotland in April, 1830
- The Moia Moia or Ocean Sunfish can produce 300 million eggs — each one smaller than the head of a pin
- The longline catch rate for albatross and other sea birds in some areas of the Pacific Ocean is 3 to 5 birds per 1,000 hooks
- The fish with the longest colloquial name is the triggerfish. Hawaiians call it HUMUHUMU-NUKUNUKU-APUAA
- Sturgeon may be the longest-lived fish. A sturgeon in Russia lived to be about 120 years old and weighed over a ton
- The sportfishing industry in the United States supports 1,178,129 jobs
- Florida led all states with 80.8 million days of fishing by recreational anglers in 1990. California was second with 68.2 million. Delaware brought up the rear with just over 2 million days of fishing.
- Illegal Columbia River sturgeon caviar currently retails for about \$18 per ounce.
- CORRECTION: Texas, which maintains records for 141 species of saltwater fish and 42 species of freshwater fish, leads the U.S. in record species, not Florida as previously listed here. Florida is second with 73 saltwater and 25 freshwater species.
- The smallest IGFA all-tackle record — 1 lb grass pickerel.
- Percentage of U.S. power boaters who fish — 87%.
- Amount spent by U.S. billfish tournament anglers in 1989 — \$179.4 million.
- Percentage of trips on which they caught billfish — 40%.
- Percentage of their billfish released — 89%.
- Number of largemouth bass over 10 pounds caught by Bob Crupi — 50 (including his 22 lb bass caught in 1991).
- Number of current IGFA line class record largemouth bass caught in California — six (all of them).
- Japan's estimated discarded bycatch while landing 106 million squid in 1990 was 41 million fish, birds and mammals, including 39 million fish; 700,000 blue sharks, 270,000 seabirds, 141,000 salmon; 24,000 mammals, and 406 sea turtles. Taiwan and Korea also participated in this fishery and had additional huge bycatches.
- In early development a blue marlin can grow more than four inches a week.
- The first bluefin tuna caught on rod and reel was landed in June 1898.
- A live coelacanth, thought to be extinct for millions of years, was first caught in 1938.
- Of 153 species recently assessed by the National Marine Fisheries Service, 65 species or 42% are currently over-utilized.

## When Your Fish Swallows the Hook, It Can Still Survive

There was no thought of science as the angler sped towards the diving birds. Only that the activity held promise of the last chance of the day to have fresh fish for supper. The birds were working a narrow cut with current rushing into the ship channel.

Action came on the first cast. A nice flounder. Then another. Then a small speck. The fish was avid, and had swallowed the hook. It measured less than 12 inches, so the hook was carefully removed from the throat and the fish released. The fish went upside down, probably dead.

One more try, and another avid speck. This one made the measure and joined the flounders on ice. The next was under sized and had also swallowed the hook.

Then came a thought. If the fish would probably die from having the single hook removed, why not try cutting the leader and leaving the hook in the fish? This was done, the fish carefully measured at 11 3/4 inches, tag No. L504639 inserted, and the fish returned to the water.

The angler thought it was a wasted tag, because the fish looked like it couldn't make it, but the current quickly carried it out of netting range.

Twenty-three days later Steve was on his way home in a rented skiff. His first trip in a long time. At least if he hadn't caught any fish, he was doing the two off-duty policemen some good. Their motor had failed,

(Continued)

and Steve was towing them back to the dock. In appreciation he was given some fish and fishing advice. The advice included location, baits and techniques. The kind of information one usually takes with a grain of salt, but this was believable because it was offered in thanks for a tow home.

That evening Steve noticed the tag on one of the specks as he was filleting the catch of the day. The next morning he called LSU Sea Grant to report the tag return. The report was FAXed to the tagging program chairman in New Orleans. The matchup on the release was displayed on the computer.

Bingo! It was that sure-to-die fish. What happened? Would it have survived longer? Where was the hook? How had it grown 1/2 inch? An anxious wait until late in the afternoon when Steve answered the phone. The carcass had been put outside in a plastic bag for the trash pick up. "Beyond the call of duty" nearby GCCA members rushed over to recover the bag, put the partially decomposed fish on ice, and deliver the fish for autopsy.

The next day the remains were delivered to the staff at the Aquarium of the Americas. Examination showed no scars in the throat where the hook penetrated. What was left of the hook was found in the stomach. Half of the hook had broken off and was gone. The remaining part of the break looked as if the hook had been made brittle, possibly by stomach acids.

The barb and half of the bend had penetrated the stomach wall, and was in the body cavity. A substantial amount of heavy tissue had already been built around the barb—the beginning of the "soft pearl" that LSU Coastal Fishery Institute biologists report finding in many fish.

The filleted carcass measured 12 1/4 inches. Unanswered is whether the fish grew from capture to capture, or if the carcass stretched when the fish relaxed—a phenomena observed by Texas biologists.

The conclusion of the aquarium experts was that the fish would have survived the first capture. One thing is certain. From now on I'm giving the hook to any released fish that swallows it.—*MAUMUS CLAVERIE.*

## 21 States Representing 156 Anglers Set New Record

For the first time in 16 years since 1976, the NBAD had more than 20 states to represent 156 participants at the 16th Annual Team Tournament at Kentucky Lake at Benton, Ky. on June 11, 12, 13, 1991.

The new 21-state record eliminated the previous of 18 set in 1989 at Lake Barkley in Kentucky.

## 46 Rookies Set New Record at Kentucky Lake

The old record of 43 rookies set at Kentucky Lake in 1987 was broken by a new record of 46 who competed at the same lake on June 11, 12, 13, 1991.

They came from 12 different states to establish the new record. The largest group of rookies represented Ohio - 17.

## New Record: 32 Anglers Caught 10 lbs. & Over for 3 Days

32 bass anglers brought and registered their catches totaling 10 pounds and over for three days at Kentucky Lake on June 11, 12, 13, 1991. The new record wiped out the old record of 19 set in 1983 at Lake Eufaula in Okla., in 1989 at Lake Barkley in Ky. and in 1990 at Lake Sam Rayburn in Texas.

## New Record: 29 Teams Caught 10 lbs. & Over in One Day

29 teams also set another new record for catching 10 pounds and over in one day in NBAD history at Kentucky Lake in June 1991. The new record erased the previous record of 18 set in 1989 at Lake Barkley in Kentucky.

## New Record: 33 Teams Caught 10 lbs. & Over for 3 Days

The new record of 33 teams caught 10 lbs. and over for three days was established at Kentucky Lake on June 13, 1991. It broke the previous record of 27 set in 1989 at Lake Barkley in Kentucky.

## 73 Per cent of 483 Participants Caught Bass at Tournaments Since 1976

The NBAD acknowledges that 73 per cent of 483 participants have caught bass at tournaments since 1976.

It shows that there are 352 anglers caught bass and 131 ones did not catch any bass.

The true fact of this figure is based on the "LIST OF ANGLERS WHO PARTICIPATED IN TOURNAMENTS FROM 1976 TO 1991" on page 31 and "TOTAL WEIGHT OF BASS CAUGHT BY ANGLERS FROM 1976 TO 1991" on page 39 of this issue.

# Statistical Records

## NUMBER OF TEAMS CAUGHT 60 LBS. AND OVER FOR THREE DAYS

1983 = 1

## NUMBER OF TEAMS CAUGHT 50 LBS. AND OVER FOR THREE DAYS

1983 = 3

## NUMBER OF TEAMS CAUGHT 40 LBS. AND OVER FOR THREE DAYS

1981 = 1      1990 = 1  
1983 = 3      1991 = 2  
1989 = 1

## NUMBER OF TEAMS CAUGHT 30 LBS. AND OVER FOR THREE DAYS

1980 = 1      1989 = 4  
1981 = 1      1990 = 2  
1983 = 5      1991 = 7

## NUMBER OF TEAMS CAUGHT 25 LBS. AND OVER FOR THREE DAYS

1980 = 1      1989 = 7  
1981 = 1      1990 = 2  
1983 = 6      1991 = 13  
1986 = 2

## NUMBER OF TEAMS CAUGHT 20 LBS. AND OVER FOR THREE DAYS

1979 = 2      1986 = 3  
1980 = 3      1987 = 0  
1981 = 1      1988 = 4  
1982 = 1      1989 = 9  
1983 = 7      1990 = 7  
1984 = 3      1991 = 18  
1985 = 1

## NUMBER OF TEAMS CAUGHT 15 LBS. AND OVER FOR THREE DAYS

1978 = 0      1985 = 3  
1979 = 3      1986 = 4  
1980 = 6      1987 = 4  
1981 = 3      1988 = 7  
1982 = 3      1989 = 16  
1983 = 9      1990 = 12  
1984 = 5      1991 = 25

## NUMBER OF TEAMS CAUGHT 10 LBS. AND OVER FOR THREE DAYS

1978 = 0      1985 = 6  
1979 = 7      1986 = 11  
1980 = 13      1987 = 14  
1981 = 6      1988 = 11  
1982 = 10      1989 = 27  
1983 = 15      1990 = 26  
1984 = 9      1991 = 33

## NUMBER OF TEAMS CAUGHT 15 LBS. AND OVER IN ONE DAY

1980 = 1      1989 = 2  
1981 = 1      1990 = 2  
1983 = 7      1991 = 7  
1984 = 1

## NUMBER OF TEAMS CAUGHT 10 LBS. AND OVER IN ONE DAY

1978 = 0      1985 = 2  
1979 = 3      1986 = 4  
1980 = 4      1987 = 3  
1981 = 2      1988 = 4  
1982 = 0      1989 = 18  
1983 = 16      1990 = 8  
1984 = 3      1991 = 29

## NUMBER OF INDIVIDUALS CAUGHT 15 LBS. AND OVER FOR THREE DAYS

1976 = 1      1984 = 2  
1977 = 2      1985 = 1  
1978 = 0      1986 = 2  
1979 = 1      1987 = 0  
1980 = 3      1988 = 1  
1981 = 3      1989 = 8  
1982 = 0      1990 = 4  
1983 = 9      1991 = 16

## NUMBER OF INDIVIDUALS CAUGHT 10 LBS. AND OVER FOR THREE DAYS

1976 = 5      1984 = 4  
1977 = 7      1985 = 4  
1978 = 0      1986 = 7  
1979 = 4      1987 = 5  
1980 = 8      1988 = 7  
1981 = 5      1989 = 19  
1982 = 5      1990 = 19  
1983 = 19      1991 = 32

## NUMBER OF INDIVIDUALS CAUGHT 15 LBS. AND OVER IN ONE DAY

1981 = 1  
1983 = 4  
1991 = 2

## NUMBER OF INDIVIDUALS CAUGHT 10 LBS. AND OVER IN ONE DAY

1976 = 1      1984 = 0  
1977 = 1      1985 = 0  
1978 = 0      1986 = 0  
1979 = 0      1987 = 1  
1980 = 1      1988 = 1  
1981 = 2      1989 = 3  
1982 = 0      1990 = 3  
1983 = 11      1991 = 12

## Table of Weight

The purpose of this table of conversion of weight is to present in convenient form the weight table useful for tournaments and local meets.

<u>Pound</u>	<u>Ounce</u>	<u>Metric</u>
1/8 lb.	= 2 oz.	= .1250
1/4 lb.	= 4 oz.	= .2500
3/8 lb.	= 6 oz.	= .3750
1/2 lb.	= 8 oz.	= .5000
5/8 lb.	= 10 oz.	= .6250
3/4 lb.	= 12 oz.	= .7500
7/8 lb.	= 14 oz.	= .8750
1 pound	= 16 oz.	= 1.0000

<u>Ounce</u>	<u>Metric</u>
1 oz.	= .0625
2 oz.	= .1250
3 oz.	= .1875
4 oz.	= .2500
5 oz.	= .3125
6 oz.	= .3750
7 oz.	= .4375
8 oz.	= .5000
9 oz.	= .5625
10 oz.	= .6250
11 oz.	= .6875
12 oz.	= .7500
13 oz.	= .8125
14 oz.	= .8750
15 oz.	= .9375
16 oz.	= 1.0000

# Result of Final Standing of First 3 Teams

## Best Total Weight of Bass

### Top 10

(1983)	1. 85 lbs. 14 oz. ....	Gene Amons & Harry Trahan
	2. 54 lbs. 8 oz. ....	Dwight Jorgensen & Carlus Worth
	3. <u>53 lbs. 0 oz.</u> ....	Dennis Hicks & Charles Marsh, Jr.
	193 lbs. 6 oz.	
(1991)	1. 48.83 lbs. ....	Ricky Cooper & Charles Ingram, Jr.
	2. 41.65 lbs. ....	Ronald Smith & Judith Gaal
	3. <u>37.47 lbs.</u> ....	Aaron Lange & Dennis Bacon
	127.95 lbs.	
(1989)	1. 40.02 lbs. ....	Michael Branch & James Greenwood
	2. 39.14 lbs. ....	Roger Stewart & Cecil Koonce
	3. <u>32.66 lbs.</u> ....	Edward Wood & Medford Magill
	111.82 lbs.	
(1990)	1. 40.15 lbs. ....	Jesse Carrizales & Juan Carrizales, Jr.
	2. 32.85 lbs. ....	Charles Marsh, Jr. & Karl Nygaard
	3. <u>24.67 lbs.</u> ....	James Ashley & John Coggins-Peckham
	97.67 lbs.	
(1981)	1. 47 lbs. 8 oz. ....	Gene Amons & Harry Trahan
	2. 15 lbs. 15 oz. ....	Alfred Crager & Frank Jackson
	3. <u>15 lbs. 15 oz.</u> ....	Bubba Lorenz & Homer West
	79 lbs. 6 oz.	
(1986)	1. 26 lbs. 3 oz. ....	Jerry Belew, Jr. & David King
	2. 25 lbs. 6 oz. ....	Karl Nygaard & Charles Marsh, Jr.
	3. <u>24 lbs. 2 oz.</u> ....	Mike Byrns & Winfred Larkin
	75 lbs. 11 oz.	
(1980)	1. 31 lbs. 13 oz. ....	J. B. Thomon & Harry Trahan
	2. 21 lbs. 9 oz. ....	Gene Amons & Carl Dupree
	3. <u>20 lbs. 9 oz.</u> ....	Randolph Poteat & Denzil Fewell
	73 lbs. 15 oz.	
(1988)	1. 23 lbs. 15 oz. ....	Larry Fewell & Carlos Holdridge
	2. 23 lbs. 8 oz. ....	Robert Shipley & Connis Collins
	3. <u>21 lbs. 13 oz.</u> ....	Bill Chapman & Robert Southwell
	69 lbs. 1 oz.	
(1984)	1. 23 lbs. 15 oz. ....	Edward Wood & Medford Magill
	2. 22 lbs. 12 oz. ....	Connis Collins & Robert Shipley
	3. <u>21 lbs. 5 oz.</u> ....	Roger Stewart & Cecil Koonce
	68 lbs. 0 oz.	
(1979)	1. 20 lbs. 6 oz. ....	Harry Trahan & Jimmy Semons
	2. 20 lbs. 4 oz. ....	Bubba Lorenz & Homer C. West
	3. <u>17 lbs. 15 oz.</u> ....	Camille Spivey & Roger Spivey
	58 lbs. 9 oz.	

# Best Total Heaviest Stringers Caught by Teams for 3 Days

(20 lbs. and over)

1.	- 85 lbs. 14 oz.	- 1983	- Gene Amons & Harry Trahan
2.	- 54 lbs. 8 oz.	- 1983	- Dwight Jorgensen & Carlus Worth
3.	- 53 lbs. 0 oz.	- 1983	- Dennis Hicks & Charles Marsh, Jr.
4.	- 48.83 lbs.	- 1991	- Ricky Cooper & Charles Ingram, Jr.
5.	- 47 lbs. 8 oz.	- 1981	- Gene Amons & Harry Trahan
6.	- 41.65 lbs.	- 1991	- Ronald Smith & Judith Gaal
7.	- 40.15 lbs.	- 1990	- Jesse Carrizales & Juan Carrizales, Jr.
8.	- 40.02 lbs.	- 1989	- Michael Branch & James Greenwood
9.	- 39.14 lbs.	- 1989	- Roger Stewart & Cecil Koonce
10.	- 37.47 lbs.	- 1991	- Aaron Lange & Dennis Bacon
11.	- 34.57 lbs.	- 1991	- Dale Granger & Ronald Delvisco
12.	- 32.85 lbs.	- 1990	- Charles Marsh, Jr. & Karl Nygaard
13.	- 32.66 lbs.	- 1989	- Edward Wood & Medford Magill
14.	- 31 lbs. 15 oz.	- 1983	- Robert Southwell & Bill Chapman
15.	- 31 lbs. 13 oz.	- 1980	- Harry Trahan & J. B. Thomon
16.	- 31 lbs. 7 oz.	- 1983	- Abel Garcia & John Coggins-Peckham
17.	- 31.37 lbs.	- 1991	- Gene Amons & Keith James
18.	- 31.36 lbs.	- 1991	- Thomas McClintock & Glenn Mueller
19.	- 31.06 lbs.	- 1989	- Rondale Ketchum & Stanley Ketchum
20.	- 30.96 lbs.	- 1991	- Brett Ketchum & Edward Ketchum
21.	- 29.53 lbs.	- 1991	- Danny Cochran & Charles Penland
22.	- 29.47 lbs.	- 1991	- Roger Stewart & Cecil Koonce
23.	- 28.81 lbs.	- 1991	- Ronald Stanford & William Schwall
24.	- 28.80 lbs.	- 1989	- Jack A. Zook & Ricky Cooper
25.	- 28.75 lbs.	- 1989	- Dennis Bacon & Aaron Lange
26.	- 28.66 lbs.	- 1991	- Roger Kays, Jr. & Patrick Ferguson
27.	- 28.49 lbs.	- 1991	- Jack A. Zook & Elen R. Zook
28.	- 28.06 lbs.	- 1991	- James Moose & James Greenwood
29.	- 27 lbs. 9 oz.	- 1983	- Kenneth Clark & Wayne Mnich
30.	- 26 lbs. 3 oz.	- 1986	- Jerry Belew, Jr. & David King
31.	- 25 lbs. 6 oz.	- 1986	- Karl Nygaard & Charles Marsh, Jr.
32.	- 25.30 lbs.	- 1989	- Brett Ketchum & Barry Santens
33.	- 24.67 lbs.	- 1989	- Gene Amons & Keith James
34.	- 24.19 lbs.	- 1990	- James Ashley & John Coggins-Peckham
35.	- 24 lbs. 2 oz.	- 1986	- Michael Byrns & Winfred Larkin
36.	- 23 lbs. 15 oz.	- 1984	- Medford Magill & Edward Wood
37.	- 23 lbs. 15 oz.	- 1988	- Larry Fewell & Carlos Holdridge
38.	- 23.86 lbs.	- 1991	- Juan Carrizales, Jr. & Jesse Carrizales
39.	- 23.63 lbs.	- 1991	- Raymond McClintock & Kenneth Stehle
40.	- 23 lbs. 8 oz.	- 1988	- Connis Collins & Robert Shipley
41.	- 23.28 lbs.	- 1991	- Michael Byrns & Alan D. Rork
42.	- 23.14 lbs.	- 1990	- Michael Branch & James Greenwood
43.	- 22.80 lbs.	- 1990	- Dennis Bacon/Mack Wilson/Thomas Rogers
44.	- 22 lbs. 12 oz.	- 1984	- Connis Collins & Robert Shipley
45.	- 22 lbs. 7 oz.	- 1983	- Jack A. Zook & Ralph Kruger
46.	- 22.32 lbs.	- 1989	- Kevin Smith & Dale Granger
47.	- 21.96 lbs.	- 1990	- Medford Magill & Edward Wood
48.	- 21 lbs. 13 oz.	- 1988	- Robert Southwell & Bill Chapman
49.	- 21.62 lbs.	- 1991	- Roger Spivey & Larry Fewell
50.	- 21 lbs. 9 oz.	- 1980	- Gene Amons & Carl Dupree
51.	- 21.45 lbs.	- 1990	- Dale Wentz, Sr. & Thomas Davis
52.	- 21 lbs. 5 oz.	- 1984	- Roger Stewart & Cecil Koonce
53.	- 21 lbs. 2 oz.	- 1982	- Alfred Crager & Jerry Mikus, Sr.
54.	- 21 lbs. 1 oz.	- 1985	- Gene Amons & Harry Trahan
55.	- 20 lbs. 9 oz.	- 1980	- Randolph Poteat & Denzil Fewell
56.	- 20 lbs. 6 oz.	- 1979	- Harry Trahan & Jimmy Semons
57.	- 20 lbs. 6 oz.	- 1988	- Thomas Rodgers & Thomas Fades
58.	- 20.33 lbs.	- 1991	- Edward Wood & Medford Magill
59.	- 20 lbs. 4 oz.	- 1979	- Bubba Lorenz & Homer C. West

# Best Total Heaviest Stringers Caught by Teams for 3 Days

(15 lbs. and over)

1. - 85 lbs. 14 oz. - 1983 - Gene Amons & Harry Trahan
2. - 54 lbs. 8 oz. - 1983 - Dwight Jorgensen & Carlus Worth
3. - 53 lbs. 0 oz. - 1983 - Dennis Hicks & Charles Marsh, Jr.
4. - 48.83 lbs. - 1991 - Ricky Cooper & Charles Ingram, Jr.
5. - 47 lbs. 8 oz. - 1981 - Gene Amons & Harry Trahan
6. - 41.65 lbs. - 1991 - Ronald Smith & Judith Gaal
7. - 40.15 lbs. - 1990 - Jesse Carrizales & Juan Carrizales, Jr.
8. - 40.02 lbs. - 1989 - Michael Branch & James Greenwood
9. - 39.14 lbs. - 1989 - Roger Stewart & Cecil Koonce
10. - 37.47 lbs. - 1991 - Aaron Lange & Dennis Bacon
11. - 34.57 lbs. - 1991 - Dale Granger & Ronald Delvisco
12. - 32.85 lbs. - 1990 - Charles Marsh, Jr. & Karl Nygaard
13. - 32.66 lbs. - 1989 - Edward Wood & Medford Magill
14. - 31 lbs. 15 oz. - 1983 - Robert Southwell & Bill Chapman
15. - 31 lbs. 13 oz. - 1980 - Harry Trahan & J. B. Thomon
16. - 31 lbs. 7 oz. - 1983 - Abel Garcia & John Coggins-Peckham
17. - 31.37 lbs. - 1991 - Gene Amons & Keith James
18. - 31.36 lbs. - 1991 - Thomas McClintock & Glenn Mueller
19. - 31.06 lbs. - 1989 - Rondale Ketchum & Stanley Ketchum
20. - 30.96 lbs. - 1991 - Brett Ketchum & Edward Ketchum
21. - 29.53 lbs. - 1991 - Danny Cochran & Charles Penland
22. - 29.47 lbs. - 1991 - Roger Stewart & Cecil Koonce
23. - 28.81 lbs. - 1991 - Ronald Stanford & William Schwall
24. - 28.80 lbs. - 1989 - Jack A. Zook & Ricky Cooper
25. - 28.75 lbs. - 1989 - Dennis Bacon & Aaron Lange
26. - 28.66 lbs. - 1991 - Roger Kays, Jr. & Patrick Ferguson
27. - 28.49 lbs. - 1991 - Jack A. Zook & Elen R. Zook
28. - 28.06 lbs. - 1991 - James Moose & James Greenwood
29. - 27 lbs. 9 oz. - 1983 - Kenneth Clark & Wayne Mnich
30. - 26 lbs. 3 oz. - 1986 - Jerry Belew, Jr. & David King
31. - 25 lbs. 6 oz. - 1986 - Karl Nygaard & Charles Marsh, Jr.
32. - 25.30 lbs. - 1989 - Brett Ketchum & Barry Santens
33. - 24.67 lbs. - 1989 - Gene Amons & Keith James
34. - 24.19 lbs. - 1990 - James Ashley & John Coggins-Peckham
35. - 24 lbs. 2 oz. - 1986 - Michael Byrns & Winfred Larkin
36. - 23 lbs. 15 oz. - 1984 - Medford Magill & Edward Wood
37. - 23 lbs. 15 oz. - 1988 - Larry Fewell & Carlos Holdridge
38. - 23.86 lbs. - 1991 - Juan Carrizales, Jr. & Jesse Carrizales
39. - 23.63 lbs. - 1991 - Raymond McClintock & Kenneth Stehle
40. - 23 lbs. 8 oz. - 1988 - Connis Collins & Robert Shipley
41. - 23.28 lbs. - 1991 - Michael Byrns & Alan D. Rork
42. - 23.14 lbs. - 1990 - Michael Branch & James Greenwood
43. - 22.80 lbs. - 1990 - Dennis Bacon/Mack Wilson/Thomas Rogers
44. - 22 lbs. 12 oz. - 1984 - Connis Collins & Robert Shipley
45. - 22 lbs. 7 oz. - 1983 - Jack A. Zook & Ralph Kruger
46. - 22.32 lbs. - 1989 - Kevin Smith & Dale Granger
47. - 21.96 lbs. - 1990 - Medford Magill & Edward Wood
48. - 21 lbs. 13 oz. - 1988 - Robert Southwell & Bill Chapman
49. - 21.62 lbs. - 1991 - Roger Spivey & Larry Fewell
50. - 21 lbs. 9 oz. - 1980 - Gene Amons & Carl Dupree

(Continued)

# Best Total Heaviest Stringers Caught by Teams for 3 Days

(15 lbs. and over)

(continued)

51.	- 21.45 lbs.	- 1990	- Dale Wentz, Sr. & Thomas Davis
52.	- 21 lbs. 5 oz.	- 1984	- Roger Stewart & Cecil Koonce
53.	- 21 lbs. 2 oz.	- 1982	- Alfred Crager & Jerry Mikus, Sr.
54.	- 21 lbs. 1 oz.	- 1985	- Gene Amons & Harry Trahan
55.	- 20 lbs. 9 oz.	- 1980	- Randolph Poteat & Denzil Fewell
56.	- 20 lbs. 6 oz.	- 1979	- Harry Trahan & Jimmy Semons
57.	- 20 lbs. 6 oz.	- 1988	- Thomas Rodgers & Thomas Eades
58.	- 20.33 lbs.	- 1991	- Edward Wood & Medford Magill
59.	- 20 lbs. 4 oz.	- 1979	- Bubba Lorenz & Homer C. West
60.	- 19.98 lbs.	- 1989	- Raymond McClintock & Kenneth Stehle
61.	- 19.81 lbs.	- 1991	- Jesse Church & James Jackson
62.	- 19.72 lbs.	- 1991	- Robert Southwell & Bill Chapman
63.	- 19 lbs. 8 oz.	- 1988	- Jeff Smith & Dwight Jorgensen
64.	- 19.49 lbs.	- 1991	- Charles Marsh, Jr. & Karl Nygaard
65.	- 19.42 lbs.	- 1991	- Rondale Ketchum & Stanley Ketchum
66.	- 19 lbs. 1 oz.	- 1983	- Edward Wood & Dale Brazzle
67.	- 18.93 lbs.	- 1989	- Ronald Smith & Bobby Eakins
68.	- 18 lbs. 10 oz.	- 1982	- Cecil Koonce & Richard Lockamy
69.	- 18.38 lbs.	- 1989	- John Surber & Kenneth Kistner
70.	- 18 lbs. 4 oz.	- 1987	- Aaron Lange & Dennis Bacon
71.	- 18.16 lbs.	- 1989	- Dale Wentz, Sr. & Thomas Davis
72.	- 18.01 lbs.	- 1990	- Norman Walker & Grady Berry
73.	- 17.99 lbs.	- 1990	- Charles Murphree & Dwight Jorgensen
74.	- 17 lbs. 15 oz.	- 1979	- Roger Spivey & Camille Spivey
75.	- 17.84 lbs.	- 1989	- Brent Cormier & Rudy Brown
76.	- 17 lbs. 11 oz.	- 1985	- David Weber & Dale Granger
77.	- 17 lbs. 4 oz.	- 1982	- Gene Amons & Harry Trahan
78.	- 17 lbs. 4 oz.	- 1987	- Raymond McClintock & Thomas McClintock
79.	- 17 lbs. 1 oz.	- 1987	- Billy Bledsoe & Randolph Poteat
80.	- 17.03 lbs.	- 1991	- Randolph Poteat & Steve Morris
81.	- 16.84 lbs.	- 1989	- Jesse Church & Johnny Barnes
82.	- 16.72 lbs.	- 1989	- William Schwall & Jerry Belew, Jr.
83.	- 16.60 lbs.	- 1990	- Dale Granger & Rudy Brown
84.	- 16 lbs. 9 oz.	- 1988	- Michael Byrns & Robert Lubbehusen
85.	- 16 lbs. 6 oz.	- 1980	- Nick Lefors, Sr. & Nick Lefors, Jr.
86.	- 16 lbs. 6 oz.	- 1980	- Henry Harvard & John W. Lee
87.	- 16 lbs. 1 oz.	- 1983	- Norman Walker & Lucius Walker, Sr.
88.	- 16 lbs. 0 oz.	- 1980	- Patrick Stuckey & Morris Porter
89.	- 15.97 lbs.	- 1991	- John Surber & Jerry Mikus, Sr.
90.	- 15 lbs. 15 oz.	- 1981	- Alfred Crager & Frank Jackson
91.	- 15 lbs. 15 oz.	- 1981	- Bubba Lorenz & Homer C. West
92.	- 15 lbs. 12 oz.	- 1987	- Charles Marsh, Jr. & Karl Nygaard
93.	- 15.71 lbs.	- 1990	- Ricky Schaeffer & John Wukasch, Jr.
94.	- 15 lbs. 11 oz.	- 1984	- Albert Woodel & Billy Bledsoe
95.	- 15.67 lbs.	- 1991	- Thomas Davis & Dale Wentz, Sr.
96.	- 15 lbs. 6 oz.	- 1984	- Ralph Kruger & Mike Fischer
97.	- 15 lbs. 5 oz.	- 1986	- Jesse Church & Randolph Poteat
98.	- 15.29 lbs.	- 1990	- Danny Cochran & Patrick Stuckey
99.	- 15 lbs. 3 oz.	- 1985	- Eddie Warchesick & Clay Campbell
100.	- 15 lbs. 2 oz.	- 1988	- John Coggins-Peckham & Abel Garcia

# Best Heaviest Stringers of Bass of the Day by Teams

(10 lbs. and over)

1. - 35 lbs. 14 oz. - 1983 - Gene Amons & Harry Trahan
2. - 28 lbs. 15 oz. - 1983 - Dennis Hicks & Charles Marsh, Jr.
3. - 28 lbs. 0 oz. - 1981 - Gene Amons & Harry Trahan
4. - 26 lbs. 11 oz. - 1983 - Gene Amons & Harry Trahan
5. - 25 lbs. 10 oz. - 1983 - Dwight Jorgensen & Carlus Worth
6. - 23.67 lbs. - 1991 - Thomas McClintock & Glenn Mueller
7. - 23 lbs. 5 oz. - 1983 - Gene Amons & Harry Trahan
8. - 22.71 lbs. - 1991 - Dale Granger & Ronald Delvisco
9. - 22 lbs. 3 oz. - 1983 - Dwight Jorgensen & Carlus Worth
10. - 20.39 lbs. - 1990 - Jesse Carrizales & Juan Carrizales, Jr.
11. - 18.22 lbs. - 1989 - Michael Branch & James Greenwood
12. - 18.08 lbs. - 1991 - Ricky Cooper & Charles Ingram, Jr.
13. - 18.07 lbs. - 1991 - Ricky Cooper & Charles Ingram, Jr.
14. - 18.05 lbs. - 1989 - Edward Wood & Medford Magill
15. - 18.02 lbs. - 1991 - Ronald Smith & Judith Gaal
16. - 16.39 lbs. - 1990 - Charles Marsh, Jr. & Karl Nygaard
17. - 16.17 lbs. - 1991 - Roger Kays, Jr. & Patrick Ferguson
18. - 16 lbs. 2 oz. - 1980 - J. B. Thomon & Harry Trahan
19. - 15 lbs. 14 oz. - 1984 - Edward Wood & Medford Magill
20. - 15.61 lbs. - 1991 - Aaron Lange & Dennis Bacon
21. - 15 lbs. 8 oz. - 1983 - Dennis Hicks & Charles Marsh, Jr.
22. - 14.90 lbs. - 1989 - Cecil Koonce & Roger Stewart
23. - 14 lbs. 9 oz. - 1983 - Abel Garcia & John Coggins-Peckham
24. - 14 lbs. 9 oz. - 1988 - Charles Murphree & Jerry McGaugh
25. - 14.16 lbs. - 1991 - Edward Ketchum & Brett Ketchum
26. - 14.15 lbs. - 1989 - Gene Amons & Keith James
27. - 14.14 lbs. - 1989 - Brett Ketchum & Barry Santens
28. - 13 lbs. 15 oz. - 1986 - Jerry Belew, Jr. & David King
29. - 13 lbs. 9 oz. - 1980 - Randolph Poteat & Denzil Fewell
30. - 13.56 lbs. - 1989 - Jesse Church & Johnny Barnes
31. - 13.38 lbs. - 1991 - Juan Carrizales, Jr. & Jesse Carrizales
32. - 13.29 lbs. - 1991 - Danny Cochran & Charles Penland
33. - 13 lbs. 1 oz. - 1981 - Gene Amons & Harry Trahan
34. - 12 lbs. 15 oz. - 1986 - Winfred Larkin & Michael Byrns
35. - 12.88 lbs. - 1989 - Roger Stewart & Cecil Koonce
36. - 12.78 lbs. - 1991 - Ronald Smith & Judith Gaal
37. - 12 lbs. 12 oz. - 1983 - Bill Chapman & Robert Southwell
38. - 12.71 lbs. - 1991 - Gene Amons & Keith James
39. - 12.68 lbs. - 1991 - Ricky Cooper & Charles Ingram, Jr.
40. - 12.42 lbs. - 1991 - Roger Spivey & Larry Fewell
41. - 12 lbs. 5 oz. - 1979 - Bubba Lorenz & Homer C. West
42. - 12 lbs. 4 oz. - 1983 - Medford Magill & Robert Anderson
43. - 12.15 lbs. - 1991 - Aaron Lange & Dennis Bacon
44. - 12.14 lbs. - 1991 - Danny Cochran & Charles Penland
45. - 12 lbs. 2 oz. - 1979 - Camille Spivey & Roger Spivey
46. - 12 lbs. 0 oz. - 1983 - Kenneth Clark & Wayne Mnich
47. - 11.94 lbs. - 1991 - Jack A. Zook & Elen R. Zook
48. - 11 lbs. 15 oz. - 1983 - Kenneth Clark & Wayne Mnich

(Continued)



(Continued)

49. - 11 lbs. 15 oz. - 1985 - David Weber & Dale Granger  
50. - 11 lbs. 15 oz. - 1987 - Charles Marsh, Jr. & Karl Nygaard  
51. - 11.87 lbs. - 1990 - Ronald Smith & Bobby Fekins  
52. - 11.84 lbs. - 1990 - Dale Wentz, Sr. & Thomas F. Davis  
53. - 11 lbs. 13 oz. - 1980 - Henry Harvard & John W. Lee  
54. - 11.76 lbs. - 1991 - Gene Amons & Keith James  
55. - 11.63 lbs. - 1989 - Rondale Ketchum & Stanley Ketchum  
56. - 11.52 lbs. - 1991 - Roger Stewart & Cecil Koonce  
57. - 11 lbs. 8 oz. - 1984 - Cecil Koonce & Roger Stewart  
58. - 11 lbs. 7 oz. - 1983 - Abel Garcia & John Coggins-Peckham  
59. - 11.39 lbs. - 1990 - Medford Magill & Edward Wood  
60. - 11.36 lbs. - 1989 - Roger Stewart & Cecil Koonce  
61. - 11.35 lbs. - 1991 - James Moose & James Greenwood  
62. - 11.30 lbs. - 1990 - Charles Murphree & Dwight Jorgensen  
63. - 11 lbs. 3 oz. - 1985 - Dwight Jorgensen & Carlus Worth  
64. - 11 lbs. 2 oz. - 1983 - Jack A. Zook & Ralph Kruger  
65. - 11.11 lbs. - 1989 - Kevin Smith & Dale Granger  
66. - 11.10 lbs. - 1990 - Jesse Carrizales & Juan Carrizales, Jr.  
67. - 11.07 lbs. - 1989 - Jack A. Zook & Ricky Cooper  
68. - 11.04 lbs. - 1989 - Michael Branch & James Greenwood  
69. - 10 lbs. 15 oz. - 1988 - John Coggins-Peckham & Abel Garcia  
70. - 10.91 lbs. - 1989 - Dennis Bacon & Aaron Lange  
71. - 10.90 lbs. - 1991 - William Schwall & Ronald Stanford  
72. - 10 lbs. 14 oz. - 1983 - Edward Wood & Dale Brazzle  
73. - 10.85 lbs. - 1991 - Ronald Smith & Judith Gaal  
74. - 10.83 lbs. - 1991 - Brett Ketchum & Edward Ketchum  
75. - 10 lbs. 13 oz. - 1983 - Bill Chapman & Robert Southwell  
76. - 10.76 lbs. - 1989 - James Greenwood & Michael Branch  
77. - 10.75 lbs. - 1991 - Jack A. Zook & Elen R. Zook  
78. - 10.73 lbs. - 1989 - Ricky Cooper & Jack A. Zook  
79. - 10.72 lbs. - 1991 - James Moose & James Greenwood  
80. - 10.64 lbs. - 1991 - Roger Stewart & Cecil Koonce  
81. - 10.63 lbs. - 1991 - Raymond McClintock & Kenneth Stehle  
82. - 10.54 lbs. - 1989 - Dennis Bacon & Aaron Lange  
83. - 10 lbs. 6 oz. - 1979 - Carl Dupree & Gene Amons  
84. - 10 lbs. 6 oz. - 1988 - Michael Byrns & Robert Lubbeheusen  
85. - 10.35 lbs. - 1990 - Charles Marsh, Jr. & Karl Nygaard  
86. - 10 lbs. 5 oz. - 1980 - J. B. Thomon & Harry Trahan  
87. - 10 lbs. 5 oz. - 1984 - Connis Collins & Robert Shipley  
88. - 10.23 lbs. - 1991 - Rondale Ketchum & Stanley Ketchum  
89. - 10.21 lbs. - 1989 - Brett Ketchum & Barry Santens  
90. - 10 lbs. 3 oz. - 1986 - Michael Byrns & Winfred Larkin  
91. - 10.17 lbs. - 1991 - Jesse Church & James Jackson  
92. - 10 lbs. 2 oz. - 1986 - John Coggins-Peckham & Bobby Hallmark  
93. - 10 lbs. 2 oz. - 1987 - Michael Byrns & Robert Lubbeheusen  
94. - 10.09 lbs. - 1989 - Kenneth Stehle & Raymond McClintock  
95. - 10 lbs. 1 oz. - 1988 - Larry Fewell & Carlos Holdridge  
96. - 10 lbs. 0 oz. - 1987 - Dwight Jorgensen & Jerry Mikus, Sr.

# Total Heaviest Stringers of Bass Caught by Individuals for 3 Days

(15 lbs. and over)

1.	- 44 lbs. 4 oz.	- 1983	- Gene Amons
2.	- 41 lbs. 10 oz.	- 1983	- Harry Trahan
3.	- 37.37 lbs.	- 1991	- Ronald Smith
4.	- 33 lbs. 4 oz.	- 1983	- Dwight Jorgensen
5.	- 32.65 lbs.	- 1991	- Ricky Cooper
6.	- 27 lbs. 6 oz.	- 1983	- Dennis Hicks
7.	- 27.33 lbs.	- 1989	- Michael Branch
8.	- 26.14 lbs.	- 1990	- Jesse Carrizales
9.	- 25 lbs. 11 oz.	- 1981	- Gene Amons
10.	- 25 lbs. 10 oz.	- 1983	- Charles Marsh, Jr.
11.	- 25.16 lbs.	- 1989	- Edward Wood
12.	- 24.61 lbs.	- 1991	- James Moose
13.	- 23.42 lbs.	- 1990	- Charles Marsh, Jr.
14.	- 22.91 lbs.	- 1991	- Aaron Lange
15.	- 22.52 lbs.	- 1991	- Gene Amons
16.	- 22.41 lbs.	- 1991	- Dale Granger
17.	- 21 lbs. 13 oz.	- 1981	- Harry Trahan
18.	- 21.56 lbs.	- 1991	- Roger Kays, Jr.
19.	- 21 lbs. 4 oz.	- 1983	- Carlus Worth
20.	- 21.19 lbs.	- 1991	- Roger Stewart
21.	- 20.90 lbs.	- 1991	- Jack A. Zook
22.	- 20.89 lbs.	- 1989	- Roger Stewart
23.	- 20.64 lbs.	- 1991	- Thomas McClintock
24.	- 20.01 lbs.	- 1991	- Danny Cochran
25.	- 19.80 lbs.	- 1989	- Dennis Bacon
26.	- 19.58 lbs.	- 1989	- Rondale Ketchum
27.	- 19 lbs. 8 oz.	- 1977	- Medford Magill
28.	- 19 lbs. 8 oz.	- 1980	- Randolph Poteat
29.	- 19 lbs. 8 oz.	- 1980	- J. B. Thomon
30.	- 19 lbs. 3 oz.	- 1983	- Abel Garcia
31.	- 18 lbs. 15 oz.	- 1988	- Thomas Rodgers
32.	- 18.25 lbs.	- 1989	- Cecil Koonce
33.	- 17 lbs. 13 oz.	- 1984	- Connis Collins
34.	- 17 lbs. 5 oz.	- 1980	- Gene Amons
35.	- 17 lbs. 2 oz.	- 1983	- Bill Chapman
36.	- 17.11 lbs.	- 1989	- Gene Amons
37.	- 17 lbs. 1 oz.	- 1979	- Harry Trahan
38.	- 16 lbs. 14 oz.	- 1977	- Marcus Vahalik
39.	- 16 lbs. 10 oz.	- 1983	- Kenneth Clark
40.	- 16.54 lbs.	- 1990	- Norman Walker
41.	- 16 lbs. 8 oz.	- 1986	- Jerry Belew, Jr.
42.	- 16 lbs. 7 oz.	- 1976	- Gene Amons
43.	- 16.22 lbs.	- 1991	- Juan Carrizales, Jr.
44.	- 16 lbs. 3 oz.	- 1986	- Michael Byrns
45.	- 16.18 lbs.	- 1991	- Charles Ingram, Jr.
46.	- 16.14 lbs.	- 1991	- Edward Ketchum
47.	- 16.06 lbs.	- 1991	- Raymond McClintock
48.	- 15 lbs. 15 oz.	- 1981	- Alfred Crager
49.	- 15.51 lbs.	- 1989	- Jack A. Zook
50.	- 15 lbs. 7 oz.	- 1984	- Edward Wood
51.	- 15.29 lbs.	- 1990	- Danny Cochran
52.	- 15 lbs. 3 oz.	- 1985	- Eddie Warchesick
53.	- 15.19 lbs.	- 1991	- Charles Marsh, Jr.

# Heaviest Stringers of Bass of the Day by Individuals

(10 lbs. and over)

1.	- 20 lbs. 0 oz.	- 1983	- Gene Amons
2.	- 19.44 lbs.	- 1991	- Thomas McClintock
3.	- 17 lbs. 9 oz.	- 1983	- Dennis Hicks
4.	- 16 lbs. 5 oz.	- 1983	- Harry Trahan
5.	- 16.12 lbs.	- 1991	- Dale Granger
6.	- 15 lbs. 14 oz.	- 1983	- Harry Trahan
7.	- 15 lbs. 3 oz.	- 1981	- Gene Amons
8.	- 14.95 lbs.	- 1991	- Ronald Smith
9.	- 14 lbs. 9 oz.	- 1983	- Abel Garcia
10.	- 14 lbs. 0 oz.	- 1983	- Dwight Jorgensen
11.	- 13 lbs. 14 oz.	- 1983	- Gene Amons
12.	- 13 lbs. 3 oz.	- 1981	- Harry Trahan
13.	- 12.60 lbs.	- 1991	- Ricky Cooper
14.	- 12 lbs. 9 oz.	- 1983	- Dwight Jorgensen
15.	- 12 lbs. 8 oz.	- 1980	- Randolph Poteat
16.	- 12.49 lbs.	- 1989	- Edward Wood
17.	- 12.34 lbs.	- 1989	- Michael Branch
18.	- 12.18 lbs.	- 1991	- Juan Carrizales, Jr.
19.	- 12.16 lbs.	- 1990	- Charles Marsh, Jr.
20.	- 11 lbs. 10 oz.	- 1983	- Carlus Worth
21.	- 11.57 lbs.	- 1991	- Ronald Smith
22.	- 11 lbs. 6 oz.	- 1983	- Charles Marsh, Jr.
23.	- 11.27 lbs.	- 1991	- Ricky Cooper
24.	- 11.08 lbs.	- 1991	- Roger Kays, Jr.
25.	- 10.97 lbs.	- 1990	- Jesse Carrizales
26.	- 10.97 lbs.	- 1991	- Aaron Lange
27.	- 10 lbs. 15 oz.	- 1988	- John Coggins-Peckham
28.	- 10.85 lbs.	- 1991	- Ronald Smith
29.	- 10 lbs. 8 oz.	- 1976	- James Ashley
30.	- 10 lbs. 7 oz.	- 1977	- Medford Magill
31.	- 10 lbs. 6 oz.	- 1983	- Gene Amons
32.	- 10 lbs. 6 oz.	- 1988	- Michael Byrns
33.	- 10.36 lbs.	- 1991	- Roger Stewart
34.	- 10.28 lbs.	- 1990	- Dale Wentz, Sr.
35.	- 10.23 lbs.	- 1989	- Gene Amons
36.	- 10.11 lbs.	- 1991	- James Moose
37.	- 10 lbs. 0 oz.	- 1987	- Dwight Jorgensen

## Top 10 - Host Total Weight of Bass Caught

1.	- 961.85 lbs.	- 1991	- Kentucky Lake, Ky.	- 156 entrants
2.	- 674.65 lbs	- 1989	- Lake Barkley, Ky.	- 128 entrants
3.	- 565.52 lbs.	- 1990	- Lake Sam Rayburn, Tx.	- 122 entrants
4.	- 461 lbs. 3 oz.	- 1983	- Lake Eufaula, Ok.	- 56 emtrants
5.	- 368 lbs. 8 oz.	- 1988	- Truman Reservoir, Mo.	- 124 entrants
6.	- 327 lbs. 14 oz.	- 1987	- Kentucky Lake, Ky.	- 118 entrants
7.	- 303 lbs. 3 oz.	- 1980	- Lake Eufaula, Ala.	- 70 entrants
8.	- 284 lbs. 15 oz.	- 1986	- Bull Shoal Lake, Ar.	- 90 entrants
9.	- 281 lbs. 5 oz.	- 1984	- Kentucky Lake, Ky.	- 82 entrants
10.	- 240 lbs. 10 oz.	- 1977	- Toledo Bend Res., Tx.	- 74 entrants

## Top 10 - Team Total Heaviest - for 3 Days

1. - 85 lbs. 14 oz. - 1983 - Gene Amons & Harry Trahan
2. - 54 lbs. 8 oz. - 1983 - Dwight Jorgensen & Carlus Worth
3. - 53 lbs. 0 oz. - 1983 - Dennis Hicks & Charles Marsh, Jr.
4. - 48.83 lbs. - 1991 - Ricky Cooper & Charles Ingram, Jr.
5. - 47 lbs. 8 oz. - 1981 - Gene Amons & Harry Trahan
6. - 41.65 lbs. - 1991 - Ronald Smith & Judith Gaal
7. - 40.15 lbs. - 1990 - Jesse Carrizales & Juan Carrizales, Jr.
8. - 40.02 lbs. - 1989 - Michael Branch & James Greenwood
9. - 39.14 lbs. - 1989 - Roger Stewart & Cecil Koonce
10. - 37.47 lbs. - 1991 - Aaron Lange & Dennis Bacon

## Top 10 - Team Total Heaviest - for One Day

1. - 35 lbs. 14 oz. - 1983 - Gene Amons & Harry Trahan
2. - 28 lbs. 15 oz. - 1983 - Dennis Hicks & Charles Marsh, Jr.
3. - 28 lbs. 0 oz. - 1981 - Gene Amons & Harry Trahan
4. - 26 lbs. 11 oz. - 1983 - Gene Amons & Harry Trahan
5. - 25 lbs. 10 oz. - 1983 - Dwight Jorgensen & Carlus Worth
6. - 23.67 lbs. - 1991 - Thomas McClintock & Glenn Mueller
7. - 23 lbs. 5 oz. - 1983 - Gene Amons & Harry Trahan
8. - 22.71 lbs. - 1991 - Dale Granger & Ronald Delvisco
9. - 22 lbs. 3 oz. - 1983 - Dwight Jorgensen & Carlus Worth
10. - 20.39 lbs. - 1990 - Jesse Carrizales & Juan Carrizales, Jr.

## Top 10 - Individual Heaviest - for 3 Days

1. - 44 lbs. 4 oz. - 1983 - Gene Amons, La.
2. - 41 lbs. 10 oz. - 1983 - Harry Trahan, La.
3. - 37.37 lbs. - 1991 - Ronald Smith, Mo.
4. - 33 lbs. 4 oz. - 1983 - Dwight Jorgensen, Ok.
5. - 32.65 lbs. - 1991 - Ricky Cooper, Ga.
6. - 27 lbs. 6 oz. - 1983 - Dennis Hicks, Ks.
7. - 27.33 lbs. - 1989 - Michael Branch, N.C.
8. - 26.14 lbs. - 1990 - Jesse Carrizales, Tx.
9. - 25 lbs. 11 oz. - 1981 - Gene Amons, La.
10. - 25 lbs. 10 oz. - 1983 - Charles Marsh, Jr., Ks.

## Top 10 - Individual Heaviest - for One Day

1. - 20 lbs. 0 oz. - 1983 - Gene Amons, La.
2. - 19.44 lbs. - 1991 - Thomas McClintock, Mo.
3. - 17 lbs. 9 oz. - 1983 - Dennis Hicks, Ks.
4. - 16 lbs. 5 oz. - 1983 - Harry Trahan, La.
5. - 16.12 lbs. - 1991 - Dale Granger, La.
6. - 15 lbs. 14 oz. - 1983 - Harry Trahan, La.
7. - 15 lbs. 3 oz. - 1981 - Gene Amons, La.
8. - 14.95 lbs. - 1991 - Ronald Smith, Mo.
9. - 14 lbs. 9 oz. - 1983 - Abel Garcia, Tx.
10. - 14 lbs. 0 oz. - 1983 - Dwight Jorgensen, Ok.

## Top 10 - Bass Lunker Champions

1. - 7 lbs. 11 oz. (7.69) - 1976 - John Cloy, La.
2. - 6 lbs. 14 oz. (6.88) - 1980 - Patrick Stuckey, Tx.
3. - 6 lbs. 11 oz. (6.69) - 1987 - Charles Marsh, Jr., Ks.
4. - 6.39 lbs. - 1991 - Danny Cochran, Tn.
5. - 6 lbs. 4 oz. (6.25) - 1984 - Roger Stewart, N.C.
6. - 6.04 lbs. - 1989 - Jack A. Zook, Ind.
7. - 5 lbs. 14 oz. (5.88) - 1983 - Harry Trahan, La.
8. - 5 lbs. 11 oz. (5.69) - 1988 - Karl Nygaard, Wi.
9. - 5 lbs. 7 oz. (5.44) - 1986 - Kevin Smith, La.
10. - 4 lbs. 15 oz. (4.94) - 1977 - Gene Amons, La.

## Top 10 - Bass Lunker Winners of the Day

1. - 7 lbs. 11 oz. (7.69) - 1976 - John Cloy, La.
2. - 6 lbs. 14 oz. (6.88) - 1980 - Patrick Stuckey, Tx.
3. - 6 lbs. 12 oz. (6.75) - 1976 - Arnold Blomdhal, La.
4. - 6 lbs. 11 oz. (6.69) - 1987 - Charles Marsh, Jr., Ks.
5. - 6.39 lbs. - 1991 - Danny Cochran, Tn.
6. - 6 lbs. 4 oz. (6.25) - 1984 - Roger Stewart, N.C.
7. - 6.04 lbs. - 1989 - Jack A. Zook, Ind.
8. - 5 lbs. 14 oz. (5.88) - 1983 - Harry Trahan, La.
9. - 5.87 lbs. - 1989 - Michael Branch, N.C.
10. - 5 lbs. 11 oz. (5.69) - 1988 - Karl Nygaard, Wi.

## Five Pound Bass & Over Club

1. - 7.69 lbs. - 1976 - John Cloy (deceased) (7.11)
2. - 6.88 lbs. - 1980 - Patrick Stuckey (6.14)
3. - 6.75 lbs. - 1976 - Arnold Blomdhal (6.12)
4. - 6.69 lbs. - 1987 - Charles Marsh, Jr. (6.11)
5. - 6.39 lbs. - 1991 - Danny K. Cochran
6. - 6.34 lbs. - 1991 - Charles Marsh, Jr.
7. - 6.25 lbs. - 1984 - Roger Stewart (6.4)
8. - 6.04 lbs. - 1989 - Jack A. Zook
9. - 5.88 lbs. - 1983 - Harry Trahan (5.14)
10. - 5.87 lbs. - 1989 - Michael Branch
11. - 5.69 lbs. - 1988 - Karl Nygaard (5.11)
12. - 5.63 lbs. - 1988 - Robert Southwell (5.10)
13. - 5.50 lbs. - 1983 - Dennis Hicks (5.8)
14. - 5.47 lbs. - 1989 - Edward P. Wood
15. - 5.44 lbs. - 1986 - Kevin Smith (5.7)
16. - 5.38 lbs. - 1988 - Jeff Smith (5.6)
17. - 5.34 lbs. - 1989 - Elen R. Zook
18. - 5.19 lbs. - 1976 - Charles Snyder (5.3)
19. - 5.13 lbs. - 1980 - Nick Lefors, Jr. (5.2)
20. - 5.13 lbs. - 1984 - Cecil Koonce (5.2)
21. - 5.10 lbs. - 1991 - Roger Kays, Jr.
22. - 5.09 lbs. - 1991 - Raymond McClintock

# All Time Tournament Records

(For 1991)

- LARGEST ATTENDANCE - 156 - 1991 - Kentucky Lake, Kentucky
- LOWEST ATTENDANCE - 56 - 1982 - Lake Eufaula, Alabama
- LOWEST ATTENDANCE - 56 - 1983 - Lake Eufaula, Oklahoma
- LARGEST NUMBER OF ROOKIES - 46 - 1991 - Kentucky Lake, Kentucky
- LOWEST NUMBER OF ROOKIES - 14 - 1979 - Toledo Bend Reservoir, Texas
- LOWEST NUMBER OF ROOKIES - 14 - 1985 - Toledo Bend Reservoir, Texas
- MOST ENTRANTS FROM STATE - 41 - Texas - 1977 - Toledo Bend Reservoir, Texas
- MOST PARTICIPANT SINCE 1976 (15 Years) - Medford Magill, Charles Marsh & Jerry Mikus
- MOST HOST OF TOURNAMENT - 3 times by Olathe Bass Club of the Deaf
- MOST TOURNAMENT SITE - 4 times at Toledo Bend Reservoir
- TOTAL PARTICIPANTS COMPETED SINCE 1976 - 483
- MOST STATE LEADING CHAMPIONSHIP TEAM - 6 times by Louisiana
- MOST CHAMPIONSHIP WINNER - 5 times by Harry Trahan, Louisiana
- MOST BASSMASTER AWARD WINNER - 3 times by Gene Amons, Louisiana
- LARGEST LUNKER - 7 lbs. 11 oz. - 1976 - John Cloy, Louisiana (deceased)
- MOST LUNKER CHAMPIONSHIP WINNER - 2 times by Harry Trahan, La.
- MOST LUNKER WINNER OF THE DAY - 3 times by Abel Garcia, Tx. & Karl Nygaard, Wi.
- HEAVIEST TEAM (1 day) - 35 lbs. 14 oz. - 1983 - Gene Amons & Harry Trahan
- TOTAL HEAVIEST TEAM (3 days) - 85 lbs. 14 oz. - 1983 - Gene Amons & Harry Trahan
- HEAVIEST INDIVIDUAL (1 day) - 20 lbs. 0 oz. - 1983 - Gene Amons
- TOTAL HEAVIEST INDIVIDUAL (3 days) - 44 lbs. 14 oz. - 1983 - Gene Amons
- MOST INDIVIDUAL CATCH OF 10 LBS. & OVER IN 3 DAYS - 10 times by Gene Amons
- MOST INDIVIDUAL CATCH OF 10 LBS. & OVER IN ONE DAY - 5 times by Gene Amons

# List of Anglers Who Participated in Tournaments from 1976 to 1991

(For the first time in the Year Anglers competed in tournaments.)

## (A)

1. Abel, Beulah .....	1986
2. Abel, Edward .....	1986
3. Adams, Fred .....	1991
4. Adams, William E. ....	1978
5. Adkins, Donald .....	1977
6. Alcorn, Bob J. ....	1983
7. Alderman, Loren .....	1979
8. Allen, Ernest .....	1987
9. Amons, S. Gene .....	1976 *
10. Anderson, John .....	1985
11. Anderson, Robert R. ....	1983
12. Andrusejko, Richard ....	1983
13. Armstrong, David .....	1976 *
14. Ashley, James E. ....	1976 *
15. Atkinson, Michael K. ....	1985
16. Aogle, Dennis .....	1989
17. Aogle, Larry S. ....	1991
18. Auld, Vick R. ....	1983

## (B)

1. Bacon, Dennis .....	1978
2. Baker, Bill .....	1991
3. Baker, Romeo M. ....	1987
4. Barganier, Guy .....	1980
5. Barker, Neal .....	1976 *
6. Barlow, Bob .....	1979
7. Barnes, Johnny .....	1986
8. Bastean, Thomas .....	1978
9. Baughman, Kenneth .....	1987
10. Bays, Daniel .....	1991
11. Beck, Todd .....	1987
12. Beckham, Andrew .....	1990
13. Belew, Jr., Jerry .....	1986
14. Bennett, Mark .....	1990
15. Berry, Grady .....	1990
16. Berzas, Robley .....	1978
17. Bethards, John .....	1989
18. Bienvenu, Jr., Martin ...	1978
19. Biggs, Linda Lou .....	1978
20. Bippus, Virgil .....	1982
21. Bitner, Charlene .....	1989
22. Bitner, William .....	1988
23. Bledsoe, Billy .....	1982
24. Blomdhal, Arnold .....	1976 *
25. Boland, Jerry .....	1977
26. Boland, Oscar .....	1976 *
27. Bollig, John .....	1978
28. Borders, Ralph .....	1991
29. Bowman, Charles .....	1981
30. Bowman, Richard .....	1987
31. Branch, Michael .....	1989
32. Braun, Robert .....	1991
33. Brazzle, Dale .....	1980
34. Broussard, Troy .....	1986
35. Brown, C. Rudy .....	1987
36. Brown, S. ....	1987
37. Brumley, Mike .....	1985
38. Bubeck, Allen .....	1986
39. Budzinski, David .....	1989
40. Butler, Mike .....	1984
41. Byrns, Michael .....	1984

## (C)

1. Caddell, James .....	1991
2. Campbell, Clay .....	1985
3. Carnes, Douglas .....	1981
4. Carrillo, Joe .....	1977
5. Carrizales, Jesse C. ....	1981
6. Carrizales, Jr., Juan ...	1981
7. Carter, Wayne .....	1976 *
8. Center, Douglas .....	1987
9. Challoner, Howard .....	1989
10. Chamagne, David .....	1979
11. Chapman, Bill E. ....	1982
12. Cheffer, Howard .....	1986
13. Cherry, Alan .....	1987
14. Cholson, Dell .....	1979
15. Church, Jesse .....	1982
16. Clark, Kenneth .....	1976 *
17. Clark, Phil .....	1978
18. Clark, Tony .....	1987
19. Cloy, John .....	1976 *
20. Coats, R., "Chip" .....	1987
21. Cochran, Danny K. ....	1990
22. Cole, Carmon .....	1989
23. Coles, Charles D. ....	1988
24. Coles, Gregory C. ....	1987
25. Collins, Sr., Bill .....	1976 *
26. Collins, Connis .....	1978
27. Cook, Joel .....	1985
28. Cooper, John A. ....	1990
29. Cooper, Ricky G. ....	1982
30. Cormier, Brent .....	1989
31. Couch, Robert .....	1987
32. Coulson, Sr., Donald ....	1989
33. Covington, Kenneth .....	1976 *
34. Cox, Clarence .....	1984
35. Cox, Robert .....	1985
36. Crager, Alfred .....	1976 *
37. Crawford, Charles .....	1976 *
38. Curbello, Gus .....	1977

## (D)

1. Daugherty, Alva .....	1984
2. Davis, Dewey .....	1976 *
3. Davis, Jerry .....	1986
4. Davis, Thomas F. ....	1986
5. Davis, Jr., Waldo .....	1987
6. Daviton, David .....	1988
7. Delvisco, Ronnie .....	1987
8. Desch, Mike .....	1984
9. Diaz, Nolan .....	1976 *
10. Dickens, Joseph H. ....	1990
11. Dickman, Daniel E. ....	1987
12. Dickover, Dennis .....	1981
13. Dignan, Leo .....	1989
14. Dolan, Jr., Russell ....	1991
15. Dopson, Ray .....	1980
16. Dornacker, Kenneth .....	1981
17. Downey, Warren E. ....	1991
18. Doyle, Thomas .....	1982
19. Drew, Jerry D. ....	1990
20. Duncan, Bobby G. ....	1991
21. Dupre, Fred .....	1977
22. Dupree, Carl .....	1978
23. DuQuin, John D. ....	1981

\* = indicates those anglers participated in  
the First Annual NBAD tournament in 1976

(E)

- 1. Eades, Thomas A. .... 1983
- 2. Eakins, Bobby G. .... 1987
- 3. Easley, Edward .... 1981
- 4. Ebberman, Dean .... 1986
- 5. Elkes, Eugene .... 1991
- 6. Ellinger, George .... 1979
- 7. Elmer, LeRoy D. .... 1984
- 8. Embree, Lloyd .... 1989
- 9. Estes, Charles .... 1980
- 10. Ethridge, John .... 1980
- 11. Evans, George W. .... 1979
- 12. Evans, Larry .... 1976 \*
- 13. Everage, Adron .... 1981

(F)

- 1. Farrell, Charles J. .... 1990
- 2. Favell, Jr., William .... 1991
- 3. Fay, Dennis .... 1991
- 4. Ferguson, Patrick .... 1983
- 5. Fewell, Denzil .... 1976 \*
- 6. Fewell, Larry W. .... 1977
- 7. Fischer, Mike .... 1984
- 8. Flarup, Carlos .... 1979
- 9. Flickner, Diane Sue .... 1978
- 10. Fonseca, Michael A. .... 1990
- 11. Fontenot, Larry .... 1976 \*
- 12. Ford, Jr., Hebron .... 1978
- 13. Ford, James E. .... 1976 \*
- 14. Francini, Jr., Ralph .... 1988
- 15. Franks, Aubrey .... 1978
- 16. Franks, Frank L. .... 1976 \*
- 17. Frederick, Jackie .... 1978
- 18. Fredrickson, Don .... 1991
- 19. French, Gary A. .... 1989
- 20. Frisby, Terry L. .... 1989
- 21. Fullerton, Jr., Delbert . 1991

(G)

- 1. Gaal, Judith .... 1991
- 2. Garcia, Abel E. .... 1976 \*
- 3. Gardner, Jr., Thomas .... 1976 \*
- 4. Gartman, Jimmy .... 1976 \*
- 5. Gentry, David .... 1988
- 6. Gilbert, Doyle .... 1977
- 7. Gill, Kevin .... 1980
- 8. Gilmore, Marion .... 1991
- 9. Gladden, Randy .... 1982
- 10. Goodyear, Charles J. .... 1987
- 11. Goodyear, Maudie .... 1987
- 12. Grace, Jim .... 1989
- 13. Granger, Dale W. .... 1979
- 14. Gray, Charles .... 1986
- 15. Green, Luther .... 1979
- 16. Greenwood, James G. .... 1984
- 17. Groff, Bob .... 1984
- 18. Gunn, Richard .... 1984
- 19. Guzan II, John .... 1988

(H)

- 1. Haag, Richard .... 1977
- 2. Hacker, Jr., Jerry .... 1991
- 3. Halbert, Russell .... 1988
- 4. Hall, Wallace .... 1988
- 5. Hallmark, Bobby R. .... 1976 \*
- 6. Hamilton, Curtis S. .... 1991
- 7. Hanna, George A. .... 1984

- 8. Harding, Bernard .... 1978
- 9. Harding, Mrs. Bernard ... 1984
- 10. Harkness, Gale .... 1987
- 11. Harkness, Gene .... 1976 \*
- 12. Harper, Robert .... 1979
- 13. Harris, Arthur D. .... 1986
- 14. Harvard, Hayden H. .... 1977
- 15. Harvard, Henry E. .... 1976 \*
- 16. Head, Bob .... 1987
- 17. Hickerson, Elmo .... 1977
- 18. Hickman, Tom .... 1991
- 19. Hicks, Dennis .... 1983
- 20. Hill, Calvin .... 1977
- 21. Holdridge, Carlos R. .... 1981
- 22. Holdridge, Virginia .... 1985
- 23. Holle, Sr., Richard .... 1986
- 24. Holmes, Harley .... 1988
- 25. Hurd, Uel .... 1978
- 26. Husted, Lee .... 1987

(I)

- 1. Ingram, Jr., Charles .... 1991

(J)

- 1. Jackson, Frank L. .... 1976 \*
- 2. Jackson, James .... 1986
- 3. Jackson, John .... 1989
- 4. James, Keith .... 1986
- 5. Jenkins, Michael .... 1991
- 6. Johnson, Dale .... 1989
- 7. Johnson, Earl .... 1988
- 8. Johnson, Sonny .... 1987
- 9. Jones, Richard .... 1991
- 10. Jordan, Eugene .... 1980
- 11. Jordan, Sr., Kenneth .... 1980
- 12. Jorgensen, Dwight .... 1981

(K)

- 1. Kallina, James .... 1981
- 2. Kays, Jr., Roger .... 1986
- 3. Keinath, David .... 1991
- 4. Keinath, Warren .... 1991
- 5. Kelly, Wayne .... 1987
- 6. Kent, James .... 1989
- 7. Kentworthy, Allan .... 1987
- 8. Ketchum, Brett .... 1986
- 9. Ketchum, Edward .... 1986
- 10. Ketchum, Rondale .... 1986
- 11. Ketchum, Stanley .... 1986
- 12. Kidd, Larry E. .... 1991
- 13. Kinderknecht, Robert .... 1977
- 14. King, David .... 1986
- 15. Kirkland, Donald .... 1976 \*
- 16. Kistner, Kenneth .... 1988
- 17. Klingensmith, Billy .... 1977
- 18. Klusman, Charles .... 1989
- 19. Koehn, Otis .... 1977
- 20. Koonce, Cecil .... 1982
- 21. Kreig, David .... 1984
- 22. Kruger, Ralph .... 1981
- 23. Kuglitsch, John .... 1980
- 24. Kushmider, Lory .... 1988
- 25. Kuskowski, Valerian .... 1986



(Continued)

(L)

1. Ladd, Lloyd ..... 1982
2. Laird, James ..... 1987
3. Lange, Aaron ..... 1978
4. Lange, Barbara ..... 1978
5. Larkin, Judith ..... 1984
6. Larkin, Winfred ..... 1980
7. Larson, Leland ..... 1988
8. LeBlanc, Dallas P. .... 1976 \*
9. LeBlanc, Maurice ..... 1990
10. LeBleu, Harold ..... 1976 \*
11. Lee, George W. .... 1984
12. Lee, Georgia ..... 1977
13. Lee, John W. .... 1976 \*
14. Lee, Ralph ..... 1977
15. Lefors, David ..... 1981
16. Lefors, Jr., Nick ..... 1977
17. Lefors, Sr., Nick ..... 1976 \*
18. Lehman, Jesse ..... 1978
19. Leland, Andrew ..... 1987
20. Lightner, James ..... 1987
21. Lockamy, Jr., Richard ... 1982
22. Long, Edgar J. .... 1988
23. Long, Virginia ..... 1988
24. Lorenz, William ..... 1976 \*
25. Love, Joe ..... 1991
26. Lubbenhausen, Robert .... 1982
27. Luttrell, Don A. .... 1987

(M)

1. Magill, Medford W. .... 1976 \*
2. Mancill, Emmett ..... 1986
3. Markham, Tommy ..... 1987
4. Marks, Roy L. .... 1990
5. Maronpot, Jeffrey ..... 1980
6. Marsh, Billy W. .... 1980
7. Marsh, Jr., Charles E. .. 1976 \*
8. Mart, Wayne ..... 1989
9. Martin, Marvin L. .... 1991
10. Maynard, Stanley ..... 1989
11. McAlear, David ..... 1986
12. McBroom, Fred ..... 1984
13. McClard, Dane ..... 1991
14. McClintock, Marvin ..... 1981
15. McClintock, Raymond ..... 1978
16. McClintock, Thomas ..... 1983
17. McCollum, Michael ..... 1988
18. McGaugh, Jerry ..... 1985
19. McMunn, Norman ..... 1978
20. McNabb, Oscar E. .... 1976 \*
21. McNabb, William E. .... 1976 \*
22. Meaux, Randy ..... 1986
23. Melance, John ..... 1979
24. Meliet, Jr., Hubert ..... 1976 \*
25. Meyers, Kevin ..... 1990
26. Middaugh, Gary ..... 1984
27. Mikus, Sr., Jerry ..... 1976 \*
28. Mikus, Sr., Mrs. Jerry .. 1976 \*
29. Miller, Martin H. .... 1984
30. Mitchell, Wiley R. .... 1980
31. Mnich, Dennis ..... 1989
32. Mnich, Mike ..... 1988
33. Mnich, Wayne ..... 1983
34. Moehring, John ..... 1976 \*
35. Monocada, Rocky ..... 1985
36. Moose, James R. .... 1991

37. Morgan, Clarence B. .... 1976 \*
38. Morris, Steve ..... 1989
39. Morris, Wendell ..... 1981
40. Morrison, Robert J. .... 1987
41. Mosby, Thomas ..... 1986
42. Motes, Ronald ..... 1986
43. Mueller, Glenn ..... 1986
44. Munz, Carl ..... 1977
45. Murphree, Charles W. .... 1981
46. Murphy, Louis ..... 1989
47. Murphy, Steve ..... 1983
48. Myers, Kevin M. .... 1991
49. Myers, Richard ..... 1991

(N)

1. Nantz, Joe ..... 1988
2. Nash, Charles ..... 1977
3. Neill, Jr., George W. ... 1977
4. Neill, Jr., Larry ..... 1983
5. Neill, Walter W. .... 1988
6. Nieluckowski, Walter .... 1987
7. Normand, David E. .... 1990
8. Nygaard, Karl A. .... 1984

(O)

1. Oates, Sr., Sammy ..... 1990
2. Oglsbee, Lanitis ..... 1977
3. O'Neal, Billy ..... 1987
4. Osborne, Bobby ..... 1982
5. Osborne, Frank W. .... 1980

(P)

1. Parsons, Wesley A. .... 1983
2. Paviofch, Mike ..... 1984
3. Pearson, Jerry ..... 1980
4. Peckham, John Coggins- .. 1981
5. Penland, Charles W. .... 1991
6. Peter, Sally ..... 1981
7. Pfof, Gary ..... 1988
8. Philip, Mark ..... 1979
9. Phillips, Leonora K. .... 1988
10. Phillips, Wayne ..... 1976 \*
11. Phillips, Wilbur ..... 1988
12. Phipps, E. Kirk ..... 1986
13. Pippins, Eugene ..... 1978
14. Pitre, Floyd ..... 1977
15. Poncar, Robert ..... 1987
16. Porter, Morris R. .... 1976 \*
17. Poteat, Randolph N. .... 1980
18. Price, Michael D. .... 1977
19. Prince, David ..... 1986

(R)

1. Ragsdale, Gary ..... 1984
2. Ramborger, Richard ..... 1981
3. Randall, Margie ..... 1984
4. Randall, Raymond D. .... 1984
5. Raney, James ..... 1983
6. Ratliff, Marla J. .... 1991
7. Reaux, Stanley ..... 1979
8. Reaves, Sam ..... 1985
9. Recob, Mike ..... 1978
10. Reekers, Merle ..... 1987
11. Reinbold, Phil ..... 1987

- 12. Renfoe, Danny ..... 1982
- 13. Rice, Glenn D. .... 1978
- 14. Riege, Wallace ..... 1989
- 15. Riley, Ralph ..... 1991
- 16. Roberts, Kenneth ..... 1978
- 17. Robillard, Larry ..... 1985
- 18. Robillard, Richard ..... 1984
- 19. Rodgers, Thomas S. .... 1976 \*
- 20. Roebuck, George R. .... 1980
- 21. Rogers, Thomas ..... 1981
- 22. Rork, Alan D. .... 1983
- 23. Rose, Roy J. .... 1987
- 24. Ross, Bill ..... 1988
- 25. Ryan, Jr., Robert ..... 1987

(S)

- 1. Saad, Demetiri ..... 1988
- 2. Salinas, Emelio G. .... 1990
- 3. Santens, Barry ..... 1987
- 4. Schaeffer, Ricky ..... 1990
- 5. Schatter, Wayne ..... 1979
- 6. Scherneck, Gerald ..... 1984
- 7. Schirmer, Glenn ..... 1984
- 8. Schmidt, Bill ..... 1982
- 9. Schoonover, Gary ..... 1991
- 10. Schrier, Susan ..... 1988
- 11. Schrier, Terry ..... 1988
- 12. Schriver, Timothy M. .... 1984
- 13. Schumacher, Chester ..... 1991
- 14. Schwall, William O. .... 1978
- 15. Scott, Joel ..... 1987
- 16. Scott, Johnny M. .... 1980
- 17. Seabaugh, Sr., Carl .... 1989
- 18. Seim, Phil ..... 1987
- 19. Semons, Jimmy ..... 1976 \*
- 20. Senter, Robert ..... 1982
- 21. Shaneyfelt, Francis ..... 1977
- 22. Shaneyfelt, Wright G. ... 1976 \*
- 23. Sheffield, Jr., Bob ..... 1977
- 24. Sheffield, Sr., Robert .. 1976 \*
- 25. Sheffield, Harry ..... 1991
- 26. Sheppard, Robert ..... 1976 \*
- 27. Sheriff, Bob ..... 1986
- 28. Shipley, Robert ..... 1984
- 29. Shutnik, Jim ..... 1989
- 30. Sims, Lawrence ..... 1978
- 31. Slaton, Jr., Thomas ..... 1978
- 32. Smith, Dennis ..... 1988
- 33. Smith, Jeff ..... 1988
- 34. Smith, Gwen ..... 1991
- 35. Smith, Kevin ..... 1985
- 36. Smith, Lester ..... 1990
- 37. Smith, Ronald ..... 1988
- 38. Snyder, Charles ..... 1976 \*
- 39. Southwell, Robert E. .... 1976 \*
- 40. Specht, Gary ..... 1989
- 41. Spivey, Camille ..... 1976 \*
- 42. Spivey, Roger ..... 1976 \*
- 43. Spurlin, Jr., Joseph .... 1980
- 44. Stack, Luther ..... 1976 \*
- 45. Stanford, Ronald ..... 1981
- 46. Stanley, Maurice ..... 1976 \*
- 47. Stapp, Jr., Fred ..... 1983
- 48. Starr, Claude J. .... 1989
- 49. Staudt, Debra ..... 1991
- 50. Steele, Jr., Raymond .... 1978
- 51. Stehle, Kenneth ..... 1989
- 52. Stephenson, Bob ..... 1978
- 53. Sternal, Robert ..... 1989
- 54. Stewart, Roger ..... 1984
- 55. Stigers, Jack ..... 1984
- 56. Stoecklein, Richard ..... 1978
- 57. Strong, Harold A. .... 1991

- 58. Strothers, Tom P. .... 1990
- 59. Stroyick, Jerry ..... 1978
- 60. Stroyick, Joe ..... 1983
- 61. Stuckey, Patrick ..... 1976 \*
- 62. Surber, Harrison ..... 1986
- 63. Surber, John ..... 1987
- 64. Szejna, Eugene ..... 1984

(T)

- 1. Theel, Charles ..... 1977
- 2. Thomas, Gayle ..... 1981
- 3. Thomon, Jr., J.B. .... 1980
- 4. Thompson, Joe ..... 1981
- 5. Thornton, L.V. .... 1977
- 6. Tigwell, Malcolm ..... 1980
- 7. Tomlin, Donald ..... 1988
- 8. Trahan, Harry L. .... 1976 \*

(U)

- 1. Unruh, Keith ..... 1977
- 2. Unser, Lee S. .... 1991

(V)

- 1. Vahalik, Debra ..... 1977
- 2. Vahalik, Marcus ..... 1977
- 3. Vanlandingham, Morris ... 1980
- 4. Vaznonis, Leonard ..... 1986

(W)

- 1. Wagner, George ..... 1977
- 2. Waisner, Larry ..... 1991
- 3. Walbert, Jerome ..... 1983
- 4. Walker, Sr., Lucius ..... 1978
- 5. Walker, Mary ..... 1985
- 6. Walker, Norman G. .... 1976 \*
- 7. Warhesick, Eddie ..... 1976 \*
- 8. Warmack, David ..... 1981
- 9. Warmack, Jr., Hollis .... 1977
- 10. Weatherly, Newton ..... 1981
- 11. Weber, David ..... 1985
- 12. Weigand, Jerry ..... 1989
- 13. Wentz, Sr., Dale ..... 1987
- 14. West, Homer C. .... 1976 \*
- 15. West, Martin A. .... 1986
- 16. Whittington, Larry ..... 1978
- 17. Whitworth, Larry ..... 1980
- 18. Williams, Billy ..... 1987
- 19. Williams, Clovis ..... 1986
- 20. Williams, Jerry D. .... 1976 \*
- 21. Wilson, Brenda ..... 1990
- 22. Wilson, Joe E. .... 1987
- 23. Wilson, Mack E. .... 1987
- 24. Wood, Edward P. .... 1978
- 25. Woodsl, Albert ..... 1981
- 26. Woodward, James ..... 1980
- 27. Worth, Carlus ..... 1981
- 28. Wright, Michael A. .... 1991
- 29. Wukasch, Jr., John ..... 1990
- 30. Wynn, Monroe ..... 1991

(Y)

- 1. Yates, Darrell ..... 1982
- 2. Young, R. D. .... 1976 \*

(Z)

- 1. Zeigler, Jack B. .... 1991
- 2. Zook, Elen R. .... 1989
- 3. Zook, Jack A. .... 1978

A total of 483 participants competed in tournaments since 1976.

# Record of Consecutive Attendance Made by Bass Anglers from 1976 to 1991

## 16th Straight Year (1976)

Medford W. Magill  
Charles E. Marsh, Jr.  
Jerry J. Mikus, Sr.

## 15th Straight Year (1977)

None

## 14th Straight Year (1978)

None

## 13th Straight Year (1979)

George W. Evans

## 12th Straight Year (1980)

None

## 11th Straight Year (1981)

Loren Alderman  
Ralph Kruger

## 10th Straight Year (1982)

Bill E. Chapman  
Edward P. Wood

## 9th Straight Year (1983)

Patrick Ferguson  
Wesley A. Parsons  
Alan D. Rork

## 8th Straight Year (1984)

Michael Byrns  
Karl Nygaard  
Raymond D. Randall

## 7th Straight Year (1985)

John Anderson

## 6th Straight Year (1986)

Thomas F. Davis  
Keith James  
Roger Kays, Jr.  
Glenn Mueller

## 5th Straight Year (1987)

Rudy Brown  
Alan Cherry  
Waldo H. Davis, Jr.  
Bobby Eakins  
Barry Santens  
Phil Seim  
Dale Wentz, Sr.  
Joe Wilson  
Mack Wilson

## 4th Straight Year (1988)

William Bitner  
Charles D. Coles  
Edgar J. Long  
Virginia Long  
Leonora Phillips  
Ronald Smith

## 3rd Straight Year (1989)

Terry Frisby  
Brett Ketchum  
Edward Ketchum  
Rondale Ketchum  
Stanley Ketchum  
Steve Morris  
Kenneth Stehle  
Jerry Weigand

## 2nd Straight Year (1990)

Danny K. Cochran  
Jerry D. Drew  
Roy L. Marks  
Lester Smith  
Brenda Wilson

# Record of how many times Anglers Competed in Tournaments from 1976 to 1991

## 1 time

- |                          |                             |                           |
|--------------------------|-----------------------------|---------------------------|
| 1. Adams, Fred           | 61. Favell, Jr., William    | 121. Maynard, Stanley     |
| 2. Adams, William E.     | 62. Fay, Dennis             | 122. McBroom, Fred        |
| 3. Adkins, Donald        | 63. Fischer, Mike           | 123. McClard, Dane        |
| 4. Alcorn, Bob J.        | 64. Flarup, Carlos          | 124. McClintock, Marvin   |
| 5. Allen, Ernest         | 65. Flickner, Diane Sue     | 125. McMunn, Norman       |
| 6. Augle, Larry S.       | 66. Fonseca, Michael A.     | 126. Meaux, Randy         |
| 7. Auld, Vick R.         | 67. Fontenot, Larry         | 127. Melance, John        |
| 8. Baker, Bill           | 68. Franks, Frank L.        | 128. Meyers, Kevin        |
| 9. Baker, Romeo M.       | 69. Frederick, Jackie       | 129. Middaugh, Gary       |
| 10. Barganier, Guy       | 70. Fredrickson, Don        | 130. Mitchell, Wiley R.   |
| 11. Bastean, Thomas      | 71. Fullerton, Jr., Delbert | 131. Mnich, Dennis        |
| 12. Bays, Daniel         | 72. Gaal, Judith            | 132. Mnich, Mike          |
| 13. Beck, Todd           | 73. Gardner, Jr., Thomas    | 133. Monocada, Rocky      |
| 14. Beckham, Andrew      | 74. Gartman, Jimmy          | 134. Moose, James R.      |
| 15. Bennett, Mark        | 75. Gilmore, Marion         | 135. Morris, Wendell      |
| 16. Berry, Grady         | 76. Gladden, Randy          | 136. Murphy, Louis        |
| 17. Berzas, Robley       | 77. Grace, Jim              | 137. Murphy, Steve        |
| 18. Bethards, John       | 78. Gray, Charles           | 138. Myers, Kevin M.      |
| 19. Biggs, Linda Lou     | 79. Green, Luther           | 139. Myers, Richard       |
| 20. Bollig, John         | 80. Guzan II, John          | 140. Nantz, Joe           |
| 21. Borders, Ralph       | 81. Haag, Richard           | 141. Nieluckowski, Walter |
| 22. Bowman, Charles      | 82. Hacker, Jr., Jerry      | 142. Normand, David E.    |
| 23. Bowman, Richard      | 83. Halbert, Russell        | 143. Oates, Sr., Sammy    |
| 24. Braun, Robert        | 84. Hall, Wallace           | 144. Oglabee, Lanitis     |
| 25. Broussard, Troy      | 85. Hamilton, Curtis S.     | 145. O'Neal, Billy        |
| 26. Brown, S.            | 86. Harding, Mrs. Bernard   | 146. Osborne, Bobby       |
| 27. Brumley, Mike        | 87. Harkness, Gene          | 147. Pavicich, Mike       |
| 28. Bubeck, Allan        | 88. Harper, Robert          | 148. Pearsons, Jerry      |
| 29. Budzinski, David     | 89. Hickman, Tom            | 149. Penland, Charles W.  |
| 30. Butler, Mike         | 90. Holdridge, Virginia     | 150. Peter, Sally         |
| 31. Caddell, James       | 91. Holmes, Harley          | 151. Pfof, Gary           |
| 32. Carrillo, Joe        | 92. Husted, Lee             | 152. Philip, Mark         |
| 33. Challoner, Howard    | 93. Ingram, Jr., Charles    | 153. Phipps, E. Kirk      |
| 34. Chamagne, David      | 94. Jackson, John           | 154. Poncar, Robert       |
| 35. Cholson, Dell        | 95. Jenkins, Michael        | 155. Prince, David        |
| 36. Clark, Phil          | 96. Johnson, Dale           | 156. Raney, James         |
| 37. Coats, R. "Chip"     | 97. Johnson, Earl           | 157. Ratliff, Marla J.    |
| 38. Cook, Joel           | 98. Johnson, Sonny          | 158. Reaves, Sam          |
| 39. Cooper, John A.      | 99. Jones, Richard          | 159. Recob, Mike          |
| 40. Cormier, Brent       | 100. Jordan, Sr., Kenneth   | 160. Renfoe, Danny        |
| 41. Couch, Robert        | 101. Keinath, David         | 161. Rice, Glenn D.       |
| 42. Coulson, Sr., Donald | 102. Keinath, Warren        | 162. Riley, Ralph         |
| 43. Cox, Robert          | 103. Kentworthy, Allan      | 163. Robillard, Larry     |
| 44. Davis, Jerry         | 104. Kidd, Larry E.         | 164. Roebuck, George R.   |
| 45. Davition, David      | 105. Kinderknecht, Robert   | 165. Rose, Roy J.         |
| 46. Desch, Mike          | 106. King, David            | 166. Ross, Bill           |
| 47. Dickens, Joseph H.   | 107. Klusman, Charles       | 167. Ryan, Jr., Robert    |
| 48. Dolan, Jr., Russell  | 108. Kreig, David           | 168. Saad, Demetiri       |
| 49. Dopson, Ray          | 109. Ladd, Lloyd            | 169. Salinas, Emelio G.   |
| 50. Downey, Warren E.    | 110. Larkin, Judith         | 170. Schaeffer, Ricky     |
| 51. Doyle, Thomas        | 111. Larson, Leland         | 171. Schatter, Wayne      |
| 52. Duncan, Bobby G.     | 112. LeBlanc, Maurice       | 172. Schoonover, Gary     |
| 53. DuQuin, John D.      | 113. LeBleu, Harold         | 173. Schrier, Susan       |
| 54. Easley, Edward       | 114. Lefors, David          | 174. Schrier, Terry       |
| 55. Elkes, Eugene        | 115. Leland, Andrew         | 175. Schumacher, Chester  |
| 56. Ellinger, George     | 116. Love, Joe              | 176. Scott, Joel          |
| 57. Ethridge, John       | 117. Mancill, Emmett        | 177. Sheffield, Jr., Bob  |
| 58. Evans, Larry         | 118. Maronpot, Jeffrey      | 178. Sheffield, Harry     |
| 59. Everage, Adron       | 119. Marsh, Billy W.        | 179. Shutnik, Jim         |
| 60. Farrell, Charles J.  | 120. Martin, Marvin L.      | 180. Sims, Lawrence       |

(Continued)

### 3 times

181. Smith, Dennis
182. Smith, Gewn
183. Snyder, Charles
184. Specht, Gary
185. Stapp, Jr., Fred
186. Staudt, Debra
187. Stephenson, Bob
188. Sternal, Robert
189. Strong, Harold A.
190. Strothers, Tom P.
191. Stroyick, Joe
192. Szejna, Eugene
193. Thomcn, Jr., J.B.
194. Thompson, Joe
195. Thornton, L.W.
196. Tigwell, Malcolm
197. Unser, Lee S.
198. Vahalik, Debra
199. Wagner, George
200. Waisner, Larry
201. Walker, Mary
202. Weatherly, Newton
203. Woodward, James
204. Wright, Michael A.
205. Wukasch, Jr., John
206. Wynn, Monroe
207. Yates, Darrell
208. Zeigler, Jack B.

### 2 times

1. Abel, Beulah
2. Abel, Edward
3. Anderson, Robert R.
4. Aogle, Dennis
5. Barlow, Bob
6. Bitner, Charlene
7. Boland, Jerry
8. Branch, Michael D.
9. Campbell, Clay
10. Carnes, Douglas
11. Cheffer, Howard
12. Clark, Tony
13. Cochran, Danny K.
14. Cole, Carmon
15. Coles, Gregory C.
16. Crawford, Charles
17. Curbello, Gus
18. Davis, Dewey
19. Delvisoo, Ronnie
20. Dignan, Leo
21. Drew, Jerry D.
22. Embree, Lloyd
23. Estes, Charles
24. Francini, Jr., Ralph

25. French, Gary A.
26. Gilbert, Doyle
27. Gill, Kevin
28. Harkness, Gale
29. Head, Bob
30. Hill, Calvin
31. Hurd, Uel
32. Jordan, Eugene
33. Kallina, James
34. Kent, James
35. Koehn, Otis
36. Kuglistsch, John
37. Kusmider, Lory
38. Kuskowski, Valerian
39. Lange, Barbara
40. Lee, George W.
41. Lee, Georgia
42. Lee, Ralph
43. Lehman, Jesse
44. Lockamy, Jr., Richard
45. Markham, Tommy
46. Marks, Roy L.
47. Mart, Wayne
48. McNabb, Oscar E.
49. Meliet, Jr., Hubert
50. Mikus, Sr., Mrs. Jerry
51. Morgan, Clarence B.
52. Mosby, Thomas
53. Motes, Ronald
54. Munz, Carl
55. Nash, Charles
56. Phillips, Wayne
57. Phillips, Wilbur
58. Pippins, Eugene
59. Ragsdale, Gary
60. Ramborger, Richard
61. Reaux, Stanley
62. Reekers, Merle
63. Riege, Wallace
64. Roberts, Kenneth
65. Robillard, Richard
66. Seabaugh, Sr., Carl
67. Senter, Robert
68. Slaton, Jr., Thomas
69. Smith, Lester
70. Spurlin, Jr., Joseph
71. Stack, Luther
72. Starr, Claude J.
73. Stroyick, Jerry
74. Thomas, Gayle
75. Vahalik, Marcus
76. Vanlandingham, Morris
77. Vazononis, Leonard
78. Whitworth, Larry
79. Wilson, Brenda
80. Young, R. D.
81. Zook, Elen R.

1. Andrusejko, Richard
2. Armstrong, David
3. Barnes, Johnny
4. Belew, Jr., Jerry
5. Bienvenu, Jr., Martin
6. Bledsoe, Billy
7. Blomdhal, Arnold
8. Boland, Oscar
9. Brazzle, Dale
10. Carrizales, Jesse C.
11. Clark, Kenneth
12. Cloy, John
13. Cooper, Ricky G.
14. Diaz, Nolan
15. Dickman, Daniel E.
16. Dickover, Dennis
17. Dupre, Fred
18. Eades, Thomas A.
19. Ebberman, Dean
20. Franks, Aubrey
21. Frisby, Terry L.
22. Gentry, David
23. Goodyear, Maudie
24. Groff, Bob
25. Gunn, Richard
26. Harris, Arthur D.
27. Hickerson, Elmo
28. Jackson, James
29. Kirkland, Donald
30. Kistner, Kenneth
31. Laird, James
32. Lefors, Jr., Nick
33. Luttrell, Don A.
34. McCollum, Michael
35. McGaugh, Jerry
36. Mnich, Wayne
37. Morris, Steve
38. Morrison, Robert J.
39. Neill, Jr., George W.
40. Neill, Walter W.
41. Reinbold, Phil
42. Scherneck, Gerald
43. Schmidt, Bill
44. Scott, Johnny M.
45. Semons, Jimmy
46. Smith, Jeff
47. Stanley, Maurice
48. Stehle, Kenneth
49. Stoecklein, Richard A.
50. Surber, Harrison
51. Tomlin, Donald
52. Weber, David
53. Weigand, Jerry
54. West, Martin A.
55. Williams, Billy
56. Williams, Jerry D.

#### 4 times

1. Atkinson, Michael
2. Baughman, Kenneth
3. Bitner, William
4. Carrizales, Jr., Juan
5. Center, Douglas
6. Coles, Charles D.
7. Covington, Kenneth
8. Cox, Clarence
9. Daugherty, Alva
10. Dupree, Carl
11. Ford, Jr., Hebron
12. Goodyear, Charles J.
13. Hanna, George A.
14. Hicks, Dennis
15. Jackson, Frank L.
16. Kelly, Wayne
17. Lightner, James
18. Long, Edgar J.
19. Long, Virginia
20. Lubbenhausen, Robert
21. Moehring, John
22. Murphree, Charles W.
23. Neill, Jr., Larry
24. Phillips, Leonora K.
25. Pitre, Floyd
26. Price, Michael D.
27. Shaneyfelt, Francis
28. Sheffield, Sr., Robert
29. Smith, Ronald
30. Stewart, Roger
31. Surber, John
32. Theel, Charles
33. Unruh, Keith
34. Walbert, Jerome
35. Whittington, Larry
36. Williams, Clovis
37. Worth, Carlus

#### 5 times

1. Ashley, James E.
2. Barker, Neal
3. Bippus, Virgil
4. Brown, C. Rudy
5. Cherry, Alan
6. Church, Jesse
7. Davis, Jr., Waldo H.
8. Eakins, Bobby G.
9. Fewell, Denzil
10. Ford, James E.
11. Greenwood, James G.
12. Harding, Bernard
13. Holle, Sr., Richard
14. Ketchum, Brett
15. Ketchum, Edward
16. Ketchum, Rondale
17. Ketchum, Stanley
18. Klingensmith, Billy

19. Koonce, Cecil
20. Lorenz, William (Bubba)
21. McAlear, David
22. McNabb, William E.
23. Osborne, Frank W.
24. Randall, Margie
25. Santens, Barry
26. Schirmer, Glenn
27. Seim, Phillip
28. Shaneyfelt, Wright G.
29. Sheppard, Robert
30. Sheriff, Bob
31. Smith, Kevin
32. Spivey, Camille
33. Steele, Jr., Raymond
34. Warchesick, Eddie
35. Wentz, Sr., Dale
36. Wilson, Joe E.
37. Wilson, Mack E.
38. Woodel, Albert

#### 6 times

1. Carter, Wayne
2. Davis, Thomas F.
3. Hallmark, Bobby R.
4. James, Keith
5. Kays, Jr., Roger
6. Larkin, Winfred
7. LeBlanc, Dallas F.
8. Miller, Martin H.
9. Mueller, Glenn
10. Rodgers, Thomas S.
11. Schriver, Timothy M.
12. Schwall, William O.
13. Shipley, Robert

#### 7 times

1. Anderson, John
2. Bacon, Dennis
3. Elmer, LeRoy D.
4. Harvard, Henry E.
5. Lefors, Sr., Nick
6. Rogers, Thomas
7. Spivey, Rogers
8. Stanford, Ronald
9. West, Homer C.

#### 8 times

1. Byrns, Michael
2. Granger, Dale W.
3. Harvard, Hayden H.
4. Jorgensen, Dwight
5. Lee, John W.
6. McClintock, Thomas
7. Nygaard, Karl A.

8. Peckham, John Coggins-
9. Randall, Raymond D.
10. Stigers, Jack
11. Walker, Sr., Lucius
12. Warmack, David

#### 9 times

1. Ferguson, Patrick
2. Fewell, Larry W.
3. Lange, Aaron
4. Parsons, Wesley A.
5. Porter, Morris R.
6. Poteat, Randolph N.
7. Rork, Alan D.

#### 10 times

1. Chapman, Bill E.
2. Collins, Jr., Bill
3. Dornacker, Kenneth
4. Holdridge, Carlos R.
5. Trahan, Harry L.

#### 11 times

1. Collins, Connis
2. Kruger, Ralph
3. Walker, Norman G.
4. Warmack, Jr., Hollis

#### 12 times

1. Alderman, Loren
2. Crager, Alfred
3. Zook, Jack A.

#### 13 times

1. Amons, S. Gene
2. Evans, George W.
3. Garcia, Abel E.
4. McClintock, Raymond
5. Southwell, Robert E.
7. Wood, Edward P.

#### 14 times

1. Stuckey, Patrick

#### 16 times

1. Magill, Medford W.
2. Marsh, Jr., Charles E.
3. Mikus, Sr., Jerry J.

**Total Weight of Bass Caught by Anglers**  
**from 1976 to 1991**  
(In alphabetical order)

(A)

1. Adams, Fred	2.58 lbs.
2. Adkins, Donald	1.38 lbs.
3. Alcorn, Bob J.	3.75 lbs.
4. Alderman, Loren	28.41 lbs.
5. Amons, S. Gene	206.43 lbs.
6. Anderson, John	23.12 lbs.
7. Anderson, Robert R.	4.63 lbs.
8. Andrusejko, Richard	11.50 lbs.
9. Armstrong, David	13.54 lbs.
10. Ashley, James E.	33.69 lbs.
11. Atkinson, Michael	5.56 lbs.
12. Augle, Larry S.	2.80 lbs.

(B)

1. Bacon, Dennis	67.95 lbs.
2. Barganier, Guy	9.19 lbs.
3. Barker, Neal	12.25 lbs.
4. Barnes, Johnny	17.64 lbs.
5. Baughman, Kenneth	10.03 lbs.
6. Bays, Daniel	3.81 lbs.
7. Beckham, Andrew	6.37 lbs.
8. Belew, Jr., Jerry	35.20 lbs.
9. Bennett, Mark	2.46 lbs.
10. Berry, Grady	1.47 lbs.
11. Bienvenu, Jr., Martin	1.00 lb.
12. Bippus, Virgil	6.13 lbs.
13. Bitner, Charlene	6.46 lbs.
14. Bitner, William	21.07 lbs.
15. Bledsoe, Billy	27.44 lbs.
16. Blomdhal, Arnold	17.75 lbs.
17. Boland, Jerry	1.00 lb.
18. Boland, Oscar	16.38 lbs.
19. Bowman, Richard	1.81 lbs.
20. Branch, Michael	39.73 lbs.
21. Braun, Robert	1.14 lbs.
22. Brazzle, Dale	13.37 lbs.
23. Brown, C. Rudy	20.09 lbs.
24. Brunley, Mike	2.94 lbs.
25. Butler, Mike	2.69 lbs.
26. Byrns, Michael	64.23 lbs.

(C)

1. Campbell, Clay	1.94 lbs.
2. Carnes, Douglas	16.63 lbs.
3. Carrillo, Joe	2.25 lbs.
4. Carrizales, Jesse	39.28 lbs.
5. Carrizales, Jr., Juan	36.36 lbs.
6. Carter, Wayne	31.89 lbs.
7. Center, Douglas	6.70 lbs.
8. Challoner, Howard	2.28 lbs.
9. Chamagne, David	1.06 lbs.
10. Chapman, Bill E.	51.01 lbs.
11. Cherry, Alan	5.67 lbs.
12. Cholson, Dell	1.06 lbs.
13. Church, Jesse	41.81 lbs.
14. Clark, Kenneth	27.94 lbs.
15. Clark, Tony	4.06 lbs.
16. Cloy, John	11.75 lbs.
17. Cochran, Danny K.	35.30 lbs.
18. Cole, Carmon	1.11 lbs.
19. Coles, Charles D.	10.15 lbs.
20. Coles, Gregory C.	1.37 lbs.
21. Collins, Sr., Bill	18.00 lbs.
22. Collins, Connis	58.89 lbs.
23. Cook, Jr., Joel	0.81 lb.

24. Cooper, John A.	1.09 lbs.
25. Cooper, Ricky G.	45.94 lbs.
26. Cormier, Brent	10.26 lbs.
27. Coulson, Sr., Donald	1.36 lbs.
28. Covington, Kenneth	17.19 lbs.
29. Cox, Clarence	6.63 lbs.
30. Cox, Robert	1.50 lbs.
31. Crager, Alfred	95.05 lbs.
32. Crawford, Charles	3.63 lbs.

(D)

1. Daugherty, Alva	7.51 lbs.
2. Davis, Thomas F.	26.19 lbs.
3. Davis, Jr., Waldo	1.13 lbs.
4. Davition, David	4.88 lbs.
5. Delvisco, Ronnie	14.59 lbs.
6. Diaz, Nolan	4.19 lbs.
7. Dickman, Daniel E.	7.11 lbs.
8. Dickover, Dennis	2.38 lbs.
9. Dolan, Jr., Russell	3.29 lbs.
10. Dopson, Ray	0.94 lb.
11. Dornacker, Kenneth	14.91 lbs.
12. Downey, Warren E.	2.18 lbs.
13. Doyle, Thomas	1.13 lbs.
14. Drew, Jerry D.	6.31 lbs.
15. Dupree, Carl	19.06 lbs.

(E)

1. Eades, Thomas A.	14.31 lbs.
2. Eakins, Bobby G.	16.92 lbs.
3. Ebberman, Dean	6.63 lbs.
4. Elkes, Eugene	5.33 lbs.
5. Elmer, LeRoy D.	7.88 lbs.
6. Estes, Charles	8.50 lbs.
7. Evans, George W.	13.41 lbs.
8. Evans, Larry	1.38 lbs.
9. Everage, Adron	1.06 lbs.

(F)

1. Farrell, Charles J.	5.10 lbs.
2. Favell, Jr., William	5.19 lbs.
3. Fay, Dennis	1.06 lbs.
4. Ferguson, Patrick	22.39 lbs.
5. Fewell, Denzil	5.81 lbs.
6. Fewell, Larry W.	60.98 lbs.
7. Fischer, Mike	6.88 lbs.
8. Ford, Jr., Hebron	5.50 lbs.
9. Ford, James E.	2.44 lbs.
10. Francini, Jr., Ralph	1.81 lbs.
11. Fredrickson, Don	7.70 lbs.
12. French, Gary A.	0.90 lb.
13. Frisby, Terry L.	10.44 lbs.
14. Fullerton, Jr., Delbert	0.99 lb.

(G)

1. Gaal, Judith	4.28 lbs.
2. Garcia, Abel E.	70.36 lbs.
3. Gardner, Jr., Thomas	2.00 lbs.
4. Gartman, Jimmy	2.50 lbs.
5. Gentry, David	1.50 lbs.
6. Gilbert, Doyle	2.00 lbs.
7. Gill, Kevin	2.00 lbs.
8. Gladden, Randy	4.06 lbs.
9. Granger, Dale W.	64.23 lbs.

(Con't.)

10. Green, Luther ..... 1.06 lbs.
11. Greenwood, James G. .... 39.19 lbs.
12. Groff, Bob ..... 9.00 lbs.
13. Guzan II, John ..... 1.44 lbs.

(H)

1. Hacker, Jr., Jerry ..... 0.97 lb.
2. Halbert, Russell ..... 2.44 lbs.
3. Hall, Wallace ..... 1.69 lbs.
4. Hallmark, Bobby R. .... 10.75 lbs.
5. Hamilton, Curtis S. .... 0.83 lb.
6. Hanna, George A. .... 11.87 lbs.
7. Harding, Bernard ..... 4.25 lbs.
8. Harkness, Gale ..... 2.38 lbs.
9. Harris, Arthur D. .... 3.06 lbs.
10. Harvard, Hayden H. .... 17.01 lbs.
11. Harvard, Henry E. .... 32.79 lbs.
12. Head, Bob ..... 3.94 lbs.
13. Hickerson, Elmo ..... 1.50 lbs.
14. Hicks, Dennis ..... 36.81 lbs.
15. Hill, Calvin ..... 4.00 lbs.
16. Holdridge, Carlos R. .... 57.64 lbs.
17. Holle, Sr., Richard ..... 1.13 lbs.
18. Holmes, Harley ..... 1.94 lbs.

(I)

1. Ingram, Jr., Charles ..... 16.18 lbs.

(J)

1. Jackson, Frank L. .... 6.05 lbs.
2. Jackson, James ..... 17.07 lbs.
3. James, Keith ..... 39.81 lbs.
4. Jenkins, Michael ..... 2.89 lbs.
5. Johnson, Dale ..... 1.61 lbs.
6. Johnson, Earl ..... 3.19 lbs.
7. Johnson, Sonny ..... 1.19 lbs.
8. Jorgensen, Dwight ..... 77.15 lbs.

(K)

1. Kallina, James ..... 10.43 lbs.
2. Kays, Jr., Roger ..... 43.08 lbs.
3. Keinath, David ..... 2.90 lbs.
4. Keinath, Warren ..... 7.19 lbs.
5. Ketchum, Brett ..... 46.72 lbs.
6. Ketchum, Edward ..... 35.10 lbs.
7. Ketchum, Rondale ..... 54.68 lbs.
8. Ketchum, Stanley ..... 28.94 lbs.
9. Kinderknecht, Robert ..... 1.25 lbs.
10. King, David ..... 9.69 lbs.
11. Kirkland, Donald ..... 6.44 lbs.
12. Kistner, Kenneth ..... 9.02 lbs.
13. Klingensmith, Billy ..... 7.76 lbs.
14. Klusman, Charles ..... 4.74 lbs.
15. Koehn, Otis ..... 0.81 lb.
16. Koonce, Cecil ..... 54.34 lbs.
17. Kruger, Ralph ..... 60.69 lbs.
18. Kuglitsch, John ..... 3.44 lbs.
19. Kushmider, Lory ..... 5.51 lbs.

(L)

1. Laird, James ..... 2.76 lbs.
2. Lange, Aaron ..... 69.00 lbs.
3. Larkin, Winfred ..... 24.55 lbs.
4. LeBlanc, Dallas P. .... 13.14 lbs.
5. Lee, George W. .... 2.57 lbs.
6. Lee, Georgia ..... 1.06 lbs.

7. Lee, John W. .... 49.86 lbs.
8. Lefors, Jr., Nick ..... 21.81 lbs.
9. Lefors, Sr., Nick ..... 34.33 lbs.
10. Leland, Andrew ..... 1.00 lb.
11. Lightner, James ..... 7.37 lbs.
12. Lockamy, Jr., Richard .. 13.63 lbs.
13. Long, Edgar ..... 17.44 lbs.
14. Long, Virginia ..... 5.49 lbs.
15. Lorenz, William (Bubba). 41.39 lbs.
16. Lubbenhausen, Robert ... 20.80 lbs.
17. Luttrell, Don A. .... 4.31 lbs.

(M)

1. Magill, Medford W. .... 117.12 lbs.
2. Mancill, Emmett ..... 1.38 lbs.
3. Marks, Roy L. .... 2.92 lbs.
4. Maronpot, Jeffrey ..... 3.94 lbs.
5. Marsh, Billy W. .... 3.38 lbs.
6. Marsh, Jr., Charles E. ... 125.17 lbs.
7. Mart, Wayne ..... 1.19 lbs.
8. Martin, Marvin L. .... 5.14 lbs.
9. McAlear, David ..... 8.97 lbs.
10. McBroom, Fred ..... 1.25 lbs.
11. McClard, Dane ..... 6.34 lbs.
12. McClintock, Raymond .... 64.79 lbs.
13. McClintock, Thomas ..... 47.46 lbs.
14. McCollum, Michael ..... 3.74 lbs.
15. McGaugh, Jerry ..... 13.20 lbs.
16. McNabb, Oscar E. .... 13.75 lbs.
17. McNabb, William E. .... 7.63 lbs.
18. Melance, John ..... 1.94 lbs.
19. Meliet, Jr., Hubert ..... 1.56 lbs.
20. Middaugh, Gary ..... 1.25 lbs.
21. Mikus, Sr., Jerry ..... 56.34 lbs.
22. Mikus, Sr., Mrs. Jerry ... 2.75 lbs.
23. Miller, Martin N. .... 4.55 lbs.
24. Mitchell, Wiley R. .... 1.50 lbs.
25. Mnich, Mike ..... 3.81 lbs.
26. Mnich, Wayne ..... 10.94 lbs.
27. Moehring, John ..... 1.44 lbs.
28. Monocada, Rocky ..... 2.81 lbs.
29. Moose, James R. .... 24.61 lbs.
30. Morris, Steve ..... 19.22 lbs.
31. Morrison, Robert J. .... 3.06 lbs.
32. Motes, Ronald ..... 3.88 lbs.
33. Mueller, Glenn ..... 24.62 lbs.
34. Murphree, Charles W. .... 24.51 lbs.
35. Murphy, Louis ..... 1.90 lbs.
36. Myers, Kevin M. .... 9.39 lbs.
37. Myers, Richard ..... 7.28 lbs.

(N)

1. Nash, Charles ..... 2.38 lbs.
2. Neill, Jr., George W. .... 5.44 lbs.
3. Neill, Jr., Larry ..... 10.96 lbs.
4. Neill, Walter W. .... 4.52 lbs.
5. Nygaard, Karl A. .... 52.14 lbs.

(O)

1. Oates, Sr., Sammy ..... 4.83 lbs.
2. Oglsbee, Lanitis ..... 2.50 lbs.
3. Osborne, Frank W. .... 9.13 lbs.

(P)

1. Parsons, Wesley A. .... 8.90 lbs.
2. Pavicich, Mike ..... 1.63 lbs.
3. Pearson, Jerry ..... 11.31 lbs.



(Con't.)

- 4. Peckham, John Coggins ... 58.28 lbs.
- 5. Penland, Charles W. .... 9.52 lbs.
- 6. Pfost, Gary ..... 4.75 lbs.
- 7. Philip, Mark ..... 2.31 lbs.
- 8. Phillips, Leonora K. .... 4.97 lbs.
- 9. Phillips, Wayne ..... 1.94 lbs.
- 10. Phillips, Wilbur ..... 0.81 lb.
- 11. Phipps, E. Kirk ..... 1.81 lbs.
- 12. Pippins, Eugene ..... 2.31 lbs.
- 13. Pitre, Floyd ..... 3.38 lbs.
- 14. Porter, Morris R. .... 26.81 lbs.
- 15. Poteat, Randolph N. .... 66.69 lbs.
- 16. Prince, David ..... 1.06 lbs.

(R)

- 1. Ragsdale, Gary ..... 12.19 lbs.
- 2. Randall, Raymond D. .... 4.82 lbs.
- 3. Ratliff, Marla J. .... 6.79 lbs.
- 4. Reaves, Sam ..... 2.25 lbs.
- 5. Reinbold, Phil ..... 5.69 lbs.
- 6. Renfoe, Danny ..... 1.13 lbs.
- 7. Roberts, Kenneth ..... 1.13 lbs.
- 8. Robillard, Larry ..... 2.81 lbs.
- 9. Robillard, Richard ..... 5.69 lbs.
- 10. Rodgers, Thomas S. .... 36.63 lbs.
- 11. Roebuck, George R. .... 7.94 lbs.
- 12. Rogers, Thomas ..... 8.75 lbs.
- 13. Rork, Alan D. .... 43.34 lbs.
- 14. Rose, Roy J. .... 1.00 lb.

(S)

- 1. Salinas, Emelio G. .... 1.41 lbs.
- 2. Santens, Barry ..... 20.51 lbs.
- 3. Schaeffer, Ricky ..... 12.00 lbs.
- 4. Scherneckar, Gerald ..... 3.06 lbs.
- 5. Schirmer, Glenn ..... 4.94 lbs.
- 6. Schmidt, Bill ..... 4.44 lbs.
- 7. Schooner, Gary ..... 1.03 lbs.
- 8. Schrier, Terry ..... 7.00 lbs.
- 9. Schriver, Timothy M. .... 6.57 lbs.
- 10. Schumacher, Chester ..... 3.96 lbs.
- 11. Schwall, William O. .... 41.74 lbs.
- 12. Scott, Johnny M. .... 3.63 lbs.
- 13. Seabaugh, Sr., Carl ..... 3.61 lbs.
- 14. Seim, Phil ..... 13.54 lbs.
- 15. Semons, Jimmy ..... 3.31 lbs.
- 16. Senter, Robert ..... 9.50 lbs.
- 17. Shaneyfelt, Francis ..... 2.56 lbs.
- 18. Shaneyfelt, Wright G. ... 17.01 lbs.
- 19. Sheffield, Sr., Robert ... 2.88 lbs.
- 20. Sheffield, Harry ..... 1.37 lbs.
- 21. Sheppard, Robert ..... 8.32 lbs.
- 22. Sheriff, Bob ..... 0.75 lb.
- 23. Shipley, Robert ..... 45.17 lbs.
- 24. Sims, Lawrence ..... 2.19 lbs.
- 25. Slaton, Jr., Thomas ..... 4.88 lbs.
- 26. Smith, Dennis ..... 4.25 lbs.
- 27. Smith, Jeff ..... 13.79 lbs.
- 28. Smith, Gwen ..... 2.01 lbs.
- 29. Smith, Kevin ..... 40.47 lbs.
- 30. Smith, Lester ..... 9.26 lbs.
- 31. Smith, Ronald ..... 57.69 lbs.
- 32. Snyder, Charles ..... 9.19 lbs.
- 33. Southwell, Robert E. .... 62.22 lbs.
- 34. Specht, Gary ..... 1.77 lbs.
- 35. Spivey, Camille ..... 34.38 lbs.
- 36. Spivey, Roger ..... 34.50 lbs.
- 37. Spurlin, Jr., Joseph .... 8.87 lbs.
- 38. Stanford, Ronald ..... 31.35 lbs.
- 39. Stanley, Maurice ..... 1.94 lbs.
- 40. Stapp, Jr., Fred ..... 4.25 lbs.

- 41. Starr, Claude J. .... 7.42 lbs.
- 42. Staudt, Debra ..... 6.19 lbs.
- 43. Steele, Jr., Raymond .... 11.69 lbs.
- 44. Stehle, Kenneth ..... 24.03 lbs.
- 45. Sternal, Robert ..... 1.17 lbs.
- 46. Stewart, Roger ..... 56.08 lbs.
- 47. Stigers, Jack ..... 25.50 lbs.
- 48. Stoecklein, Richard A. ... 4.00 lbs.
- 49. Strong, Harold A. .... 2.28 lbs.
- 50. Strothers, Tom P. .... 2.31 lbs.
- 51. Stuckey, Patrick ..... 43.69 lbs.
- 52. Surber, Harrison ..... 12.25 lbs.
- 53. Surber, John ..... 25.16 lbs.
- 54. Szejna, Eugene ..... 2.56 lbs.

(T)

- 1. Theel, Charles ..... 12.32 lbs.
- 2. Thomas, Gayle ..... 2.31 lbs.
- 3. Thomon, Jr., J.B. .... 19.50 lbs.
- 4. Thornton, L. V. .... 1.19 lbs.
- 5. Tomlin, Donald ..... 8.38 lbs.
- 6. Trahan, Harry L. .... 120.88 lbs.

(U)

- 1. Unruh, Keith ..... 5.94 lbs.

(V)

- 1. Vahilak, Debra ..... 1.00 lb.
- 2. Vahilak, Marcus ..... 19.01 lbs.
- 3. Vanlandingham, Morris ... 4.19 lbs.

(W)

- 1. Waisner, Larry ..... 2.36 lbs.
- 2. Walbert, Jerome ..... 6.69 lbs.
- 3. Walker, Sr., Lucius .... 15.32 lbs.
- 4. Walker, Norman G. .... 55.93 lbs.
- 5. Warchesiok, Eddie ..... 26.38 lbs.
- 6. Warmack, David ..... 19.74 lbs.
- 7. Warmack, Jr., Hollis ... 20.84 lbs.
- 8. Weber, David ..... 16.07 lbs.
- 9. Weigand, Jerry ..... 1.15 lbs.
- 10. Wents, Sr., Dale ..... 36.72 lbs.
- 11. West, Homer C. .... 31.25 lbs.
- 12. West, Martin A. .... 7.03 lbs.
- 13. Whittington, Larry ..... 9.43 lbs.
- 14. Whitworth, Larry ..... 1.06 lbs.
- 15. Williams, Billy ..... 10.65 lbs.
- 16. Williams, Clovis ..... 4.10 lbs.
- 17. Williams, Jerry D. .... 4.11 lbs.
- 18. Wilson, Joe E. .... 13.92 lbs.
- 19. Wilson, Mack E. .... 18.17 lbs.
- 20. Wood, Edward P. .... 102.40 lbs.
- 21. Woodel, Albert ..... 13.37 lbs.
- 22. Worth, Carlus ..... 27.75 lbs.
- 23. Wright, Michael A. .... 10.24 lbs.
- 24. Wukaseh, Jr., John ..... 3.71 lbs.

(Y)

- 1. Yates, Darrell ..... 4.81 lbs.
- 2. Yeung, R. D. .... 2.07 lbs.

(Z)

- 1. Zeigler, Jack B. .... 5.42 lbs.
- 2. Zook, Elen R. .... 10.87 lbs.
- 3. Zook, Jack A. .... 80.36 lbs.

17th ANNUAL

# National Bass Association of the Deaf

## TEAM TOURNAMENT

SPONSORED BY:

LITTLE  
ROCK  
BASS  
ANGLERS  
OF THE  
DEAF, INC.

**\$2,000**  
GUARANTEED  
TO  
1st PLACE TEAM  
WINNER

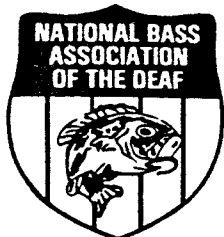

FOR FURTHER INFORMATION  
CONTACT

W. O. SCHWALL, 20 KINGSPARK CT., LITTLE ROCK, ARKANSAS 72207  
PHONE (501) 225-6415 (TDD)

42.



JUNE 16-17-18  
**1992**  
LAKE OUACHITA  
LOCATED AT  
MOUNTAIN HARBOR  
RESORT



**Mountain Harbor Resort  
And Condominiums**  
P.O. Box 807  
Mount Ida, Arkansas 71957  
(501) 867-2191  
Out of state: 1-800-832-2276

**\* SPECIAL NOTES \***

\*Two night minimum on weekends, three night minimum on Holiday Weekends.

\*One night's deposit required to guarantee all reservations. We process all credit cards immediately for deposit.



**\*\*\*\*\*CANCELLATION POLICY\*\*\*\*\***

Deposits are refunded, minus a \$7.50 service charge, only when cancellation notice reaches our office two weeks before arrival date. We cannot refund for cancellation of a guaranteed reservation made within two weeks of anticipated arrival date. We must charge for the first night of a three night stay if you call and cancel the first night.

**\*STAY SEVEN NIGHTS AND GET ONE WEEK NIGHT FREE.**

\*Weekend Rates effective Memorial Day Weekend through Labor Day Weekend.

\*Weekend Rates apply to Sunday Nights on Major Holidays.

**Our Lodge Area Units**

**Cottages**

Choose from glorious lakeviews or forest settings overlooking our west bay. Two bedrooms, two full baths, fireplace, deck - lots of room!

**With Lakeview:** \$125.00 plus tax per night  
\*Weekend rate - \$145.00 plus tax per night  
Sept. 4 until Feb. 28 - \$98.00 plus tax per night  
Request C2 or C3

**With Forest & Lakeview:** \$115.00 plus tax per night  
\*Weekend rate - \$135.00 plus tax per night  
Sept. 4 until Feb. 28 - \$89.95 plus tax per night  
Request C4, C5 or C6

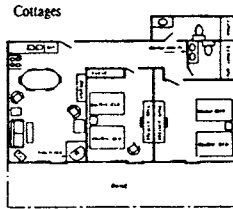

**Cabanas**

Our poolside units feature kitchen and dining area, with four double beds in two separate living areas, one bath.

\$69.95 plus tax per night  
\*Weekend rate - \$99.95 plus tax per night  
Sept.4 until Feb.28 - \$58.00 plus tax per night

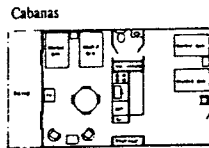

**Motel Rooms**

Our comfortable and cozy motel rooms have two double beds and sleeper sofa. Enjoy the gorgeous lake view!

**Studio or Suite**

Our lakeview kitchenette units can be rented as a single kitchenette unit or combined with the adjoining motel room as a suite. Has four double beds and two sleeper sofas, two baths.

**Motel Room** \$57.50 plus tax per night  
\*Weekend rate - \$67.50 plus tax per night  
Sept.4 until Feb.28 - \$39.95 plus tax per night

**Studio - Our One Room Kitchenette** \$69.95 plus tax per night  
\*Weekend rate - \$79.95 plus tax per night  
Sept.4 until Feb.28 \$57.00 plus tax per night

**Suite - Includes Studio and Room** \$125.00 plus tax per night  
\*Weekend rate \$145.00 plus tax per night  
Sept.4 until Feb.28 \$95.00 plus tax per night

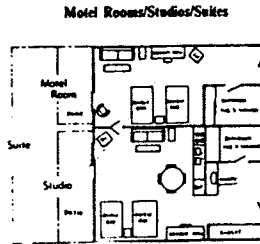

**1990**

**Lodging Rates/Floor Plans  
and  
General Information**

Featuring:  
\*A variety of comfortable lodging, from Lakeview Motel Rooms to Exclusive Condominiums - all thoughtfully appointed, most with fireplaces. Choose from Condominiums, Cottages, Motel Rooms, or a variety of Kitchenette Units.

\* The Lodge Restaurant, conveniently located, open year round, serving great home-style cooking. Casual dress.

\*Arkansas' largest marina with a complete line of marina rental equipment, campers, store, fuel, annual and overnight slip rental, fishing guide service, dive shop, marine repair facility and launching ramp.

\* Our East Cove Conference/Banquet Center featuring over 2,300 square feet of meeting/banquet area - right on the lake!

\* Our Conference/Community Building with over 1,200 square feet for meetings, family reunions and private parties.

\* Paved Launching Ramp.

\*Tennis courts, pools, heated spas, playground, recreation room, laundromat, color cable television, phone.

Managed by Resort Management, Inc.

**CONDOMINIUMS**

4 Bedroom Floor Plan

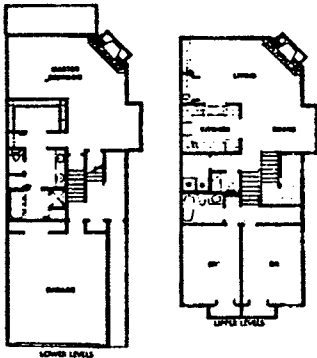

Four bedroom, two and one-half bath condominium. This beautiful unit has two fireplaces, fully-equipped kitchen, washer and dryer, large decks on two levels.

\$230.00 plus tax per night  
\*Weekend rate \$265.00 plus tax per night  
Sept.4 until Feb.28 - \$180.00 plus tax per night  
Jacuzzi \$10 more

Large 2 Bedroom Floor Plan

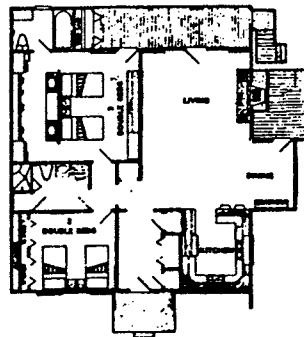

Our largest two bedroom condominiums! Big native stone fireplace, two big baths, one with dressing room. Each room has two double beds and there's even a sleeper sofa in the living room. Fully-equipped kitchen and washer and dryer. Large cedar decks. Over 1,400 square feet!

\$125.00 plus tax per night  
\*Weekend rate - \$165.00 plus tax per night  
Sept. 4 until Feb. 28 - \$96.00 plus tax per night  
Jacuzzi \$10 more

Our Smaller 2 Bedroom Floor Plan

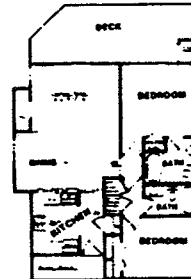

Two bedroom, two bath condominium with natural stone fireplace, fully-equipped kitchen, washer and dryer. A perfect hide-a-way for a couple, but big enough to accommodate larger groups. About 1000 square feet.

\$99.95 plus tax per night  
\*Weekend rate - \$145.00 plus tax per night  
Sept.4 until Feb.28 - \$79.95 plus tax per night

Ask about our Special Rates and Packages.

**Check Out Time is 11:00 A.M.  
Check In Time is 3:00 P.M.**

**Come to Mountain Harbor**

Mountain Harbor Resort and Condominiums is located approximately 25 miles west of Hot Springs National Park, Arkansas, just off U.S. Highway 270. Limited commercial air service is available at the Hot Springs Regional Airport and major commercial air service is available at the Little Rock Airport, one hour from Hot Springs. Car rentals are available at Hot Springs and Little Rock. For private planes, fly into Mt. Ida/Bearce Airport. Call ahead and we will be there to meet your plane.

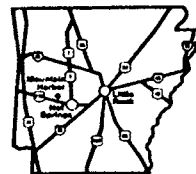

**Milage Chart**

Little Rock	78
Fort Smith	103
Texasarkana	137
Shreveport	207
Memphis	213
Tulsa	205
Dallas/	
Fort Worth	313
Oklahoma City	312
Wichita	390

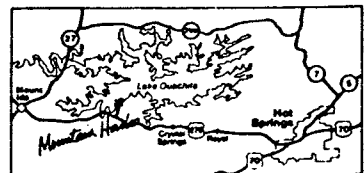

For reservations at Mountain Harbor Resort and Condominiums, or for more information, write or call:

Mountain Harbor Resort  
& Condominiums  
P.O. Box 807  
Mount Ida, Arkansas 71957  
(501) 867-2191  
1-800-832-2276 Out of State



# CRYSTAL SPRINGS

## RESORT

LAKE OUACHITA, ARKANSAS

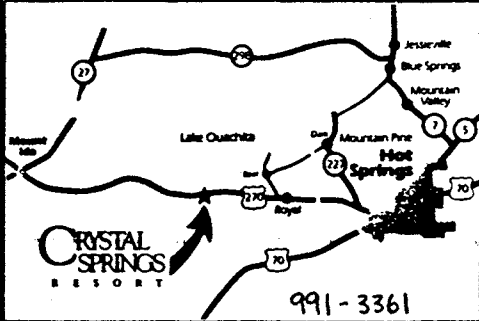

*Crystal Springs is located 15 miles west of Hot Springs off Hwy. 270, on beautiful Lake Ouachita. The resort is centered on the lake in a scenic cove.*

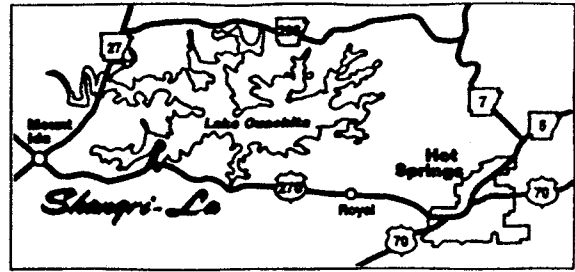

# Shangri-La

## Resort

Star Route 1, Box 257  
 Mount Ida, Arkansas 71957  
 (501) 867-2011

You're surrounded by things to do at Shangri-La. There's a swimming pool and tennis court on the grounds and great spots for picnicking and hiking. Shangri-La also has facilities for campers. It's all located at one of the prettiest spots on the lake - Shangri-La.

For more vacation fun, Shangri-La is just 27 miles from attractions, shopping, history and sightseeing adventure at Hot Springs National Park.

# ANGLER MOTEL



AIR CONDITIONED - TV -  
 KITCHENETTES - POOL -  
 (RESTAURANT NEXT DOOR)  
 (2 MILES TO CRYSTAL SPRINGS BOAT  
 LANDING)  
 HWY. 270 EAST OF MOUNT IDA

991-3334

# Colonial MOTEL

A/C - Color TV - Kitchen - Rack & Gift Shop  
**CAMPGROUND**  
 R.V. HOOKUPS (Electric & Water - Groceries & Ice)  
 Hwy. 270 - At Mountain Harbor 867-2431



# LAKE OUACHITA INN

HOME OF CAROL'S KITCHEN

Private Dining Room - Next to Airport  
 GOOD FOOD  
 CABLE TV  
 CLEAN ROOMS  
 REASONABLE RATES  
 6 MILES EAST OF MT. IDA, ARK  
 HWY 270  
**501-867-2643**

## ON BEAUTIFUL LAKE OUACHITA

(501) 867-3651

# DENBY POINT LODGE

CAFE MOTEL  
 KITCHENETTES  
 MARINA

- Motel Rooms or Furnished Housekeeping units with lake view.
- Restaurant adjoining Lodge Lobby
- Air-Conditioning, Color TV's, Outdoor Lawn Furniture, Picnic Tables, and Grills.
- Swimming Pool and Electronic Game Room.
- Large, Cozy, Rustic Lodge with Stone Fireplace.
- Complete Marina with adjacent Concrete Boat Ramp.
- Party Barge, Boats and Motors for rent.
- Large Bus Groups Welcome with Reservations.
- Conference Room for Meetings, Seminars, or Training Sessions.

Located off Highway 270  
 9 Miles East of Mount Ida  
 25 Miles West of Hot Springs

For Information and Reservations  
 Star Route 1, Box 241  
 Mount Ida, Arkansas 71957

3

**CAMPING**

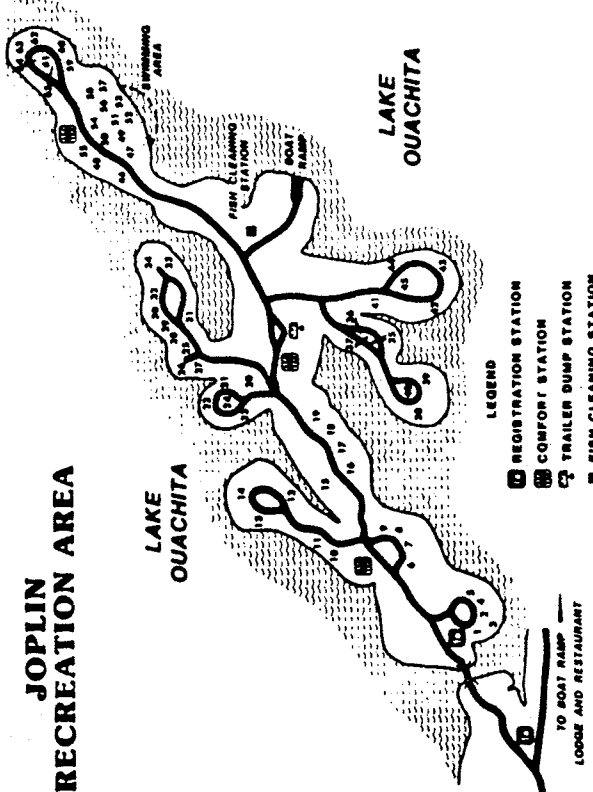

**CAMPING**

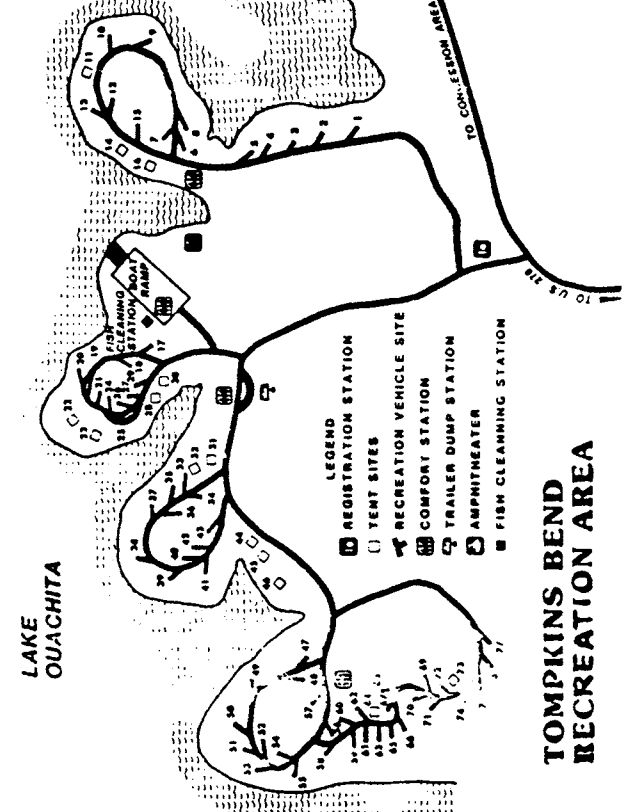

**CAMPING**

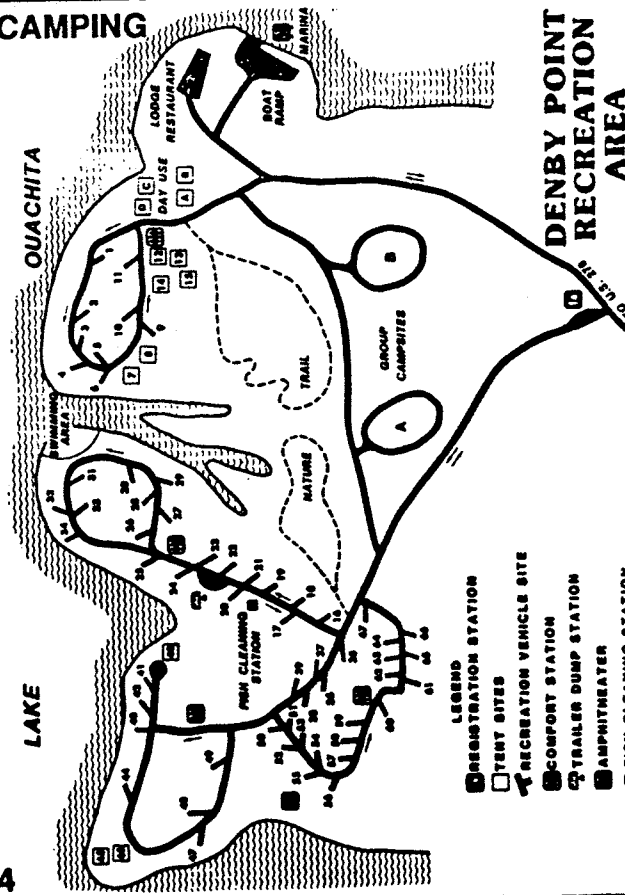

**MOUNTAIN HARBOR MARINA**

23' SKI BOAT with 230 hp Mercruiser Inboard/ Outboard  
\$195.00 per day plus fuel  
\$150.00 per half day plus fuel  
One set of skis and rope included

29' Aloha Designer Series Partybarge with 88 hp Outboard and Sundeck  
\$169.00 per day plus fuel  
\$125.00 per half day plus fuel  
Can accommodate approx. 12 people

16' Monarch Bass Boat with 50 hp Outboard, Livewells, Depth Finder, Trolling Motor  
\$85.00 per day plus fuel  
\$65.00 per half day plus fuel

14' Fishing Boat with 20 hp Outboard  
\$35.00 per day plus fuel  
\$20.00 per half day plus fuel

Marina also offers a camper's grocery/tackle store, ice, fuel, oil, and battery charging.

**Non-Resident Fishing Licenses:**  
\$6.50 for 3 days  
\$13.50 for 14 days

## There's more than bass fishing in Hot Springs

**Hot Springs** - For general information, call the Hot Springs Chamber of Commerce at 1-321-1700 or the Hot Springs Convention and Visitors Bureau at (800) 543-2284. Brochures on tourist attractions, lodging and restaurants are available at the visitors' center at Court Street and Central Avenue, open from 9 am to 5 pm Monday through Saturday, and at the Convention Auditorium office, 134 Convention Blvd., between 8 am to 5 pm Monday through Friday. Among the attractions and events:

**Josephine Tussaud Wax Museum** - 250 Central Avenue - 9 am to 4 pm daily; admission is \$4.50 for adults, \$2.25 for children. For more information, call 1-623-5836. Seven "worlds" of scenes feature tableaux including "Alice in Wonderland", the Last Supper, movie stars and medieval tortures.

**Arkansas Alligator Farm and Petting Zoo** - 847 Whittington Avenue - 9:30 am to 5:30 pm daily. Admission is \$3.00 for adults, \$2.00 for children under 12. For more information, call 1-623-6172. The farm houses more than 100 alligators and a petting zoo including raccoons, turkeys, monkeys, deer and pygmy goats.

**Ar-Scenic Spring** - 307 Mt. Ida Street - 9 am to 5 pm daily; call 1-623-1722 for more information. This gift shop, in business since 1870, sells items including crystal quartz mined near Hot Springs and Arkansas crafts items.

**Mid-America Museum** - 400 Mid-America Blvd. - 10 am to 5 pm Tuesday through Sunday. Admission is \$3.95 for adults, \$2.95 for children 5-12, free for children 4 and under; there is a \$1.00 extra charge to view the laser show. For more information, call 1-767-3461. The museum specializes in exhibits meant for educational play. Among the newer features are the "Whisper Dish", in which two people can stand at opposite ends of a large room and hear each other whispering; and the "Erosion Table", which demonstrates the effects of water on soil. There is also a 30-minute laser light show, choreographed to popular and patriotic music.

**Hot Springs Mountain Tower** - 9 am to 5 pm daily. Admission is \$2.25 for adults, \$1.75 for children. For more information, call (800) 543-2284.

**White and Yellow Duck Tours, Bus Tours** - All tours load at 410 Central Ave. The amphibious white and yellow "ducks" leave from downtown at 11 am and 2 pm daily and wind down Arkansas 7 south, where they enter Lake Hamilton for a tour of lakeside sites. Bus tours leave at 10 am and 2 pm daily, taking riders to different points of interest around the city. Tickets for all tours are \$8.00 for adults and \$4.00 for children. For more information, call 1-623-1111.

**National Park Aquarium** - 209 Central Ave. - Open from 1-5 pm Tuesday and Wednesday, 9 am to 5 pm. Thursday through Saturday and 10 am to 6 pm Sunday. Admission is \$3.00 for adults, \$2.50 for senior citizens, \$1.50 for children 4-12, free for children 3 and under. For more information, call 1-624-3474. The Aquarium displays tropical and freshwater fish and reptiles (including turtles) in natural habitats.

**Castleberry Riding Stables** - Walnut Valley Road, one mile off Arkansas 7 North - Open from 8 am to 4 pm daily; hours subject to change. Scenic mountain rides are the main attraction here; cost is \$10.00 for a one-hour trail ride and \$18.00 for a two-hour outing. The grounds also have picnic tables for those who want to bring lunch. Reservations are required; call 1-624-7291 or 1-623-6609.

# Hot Springs

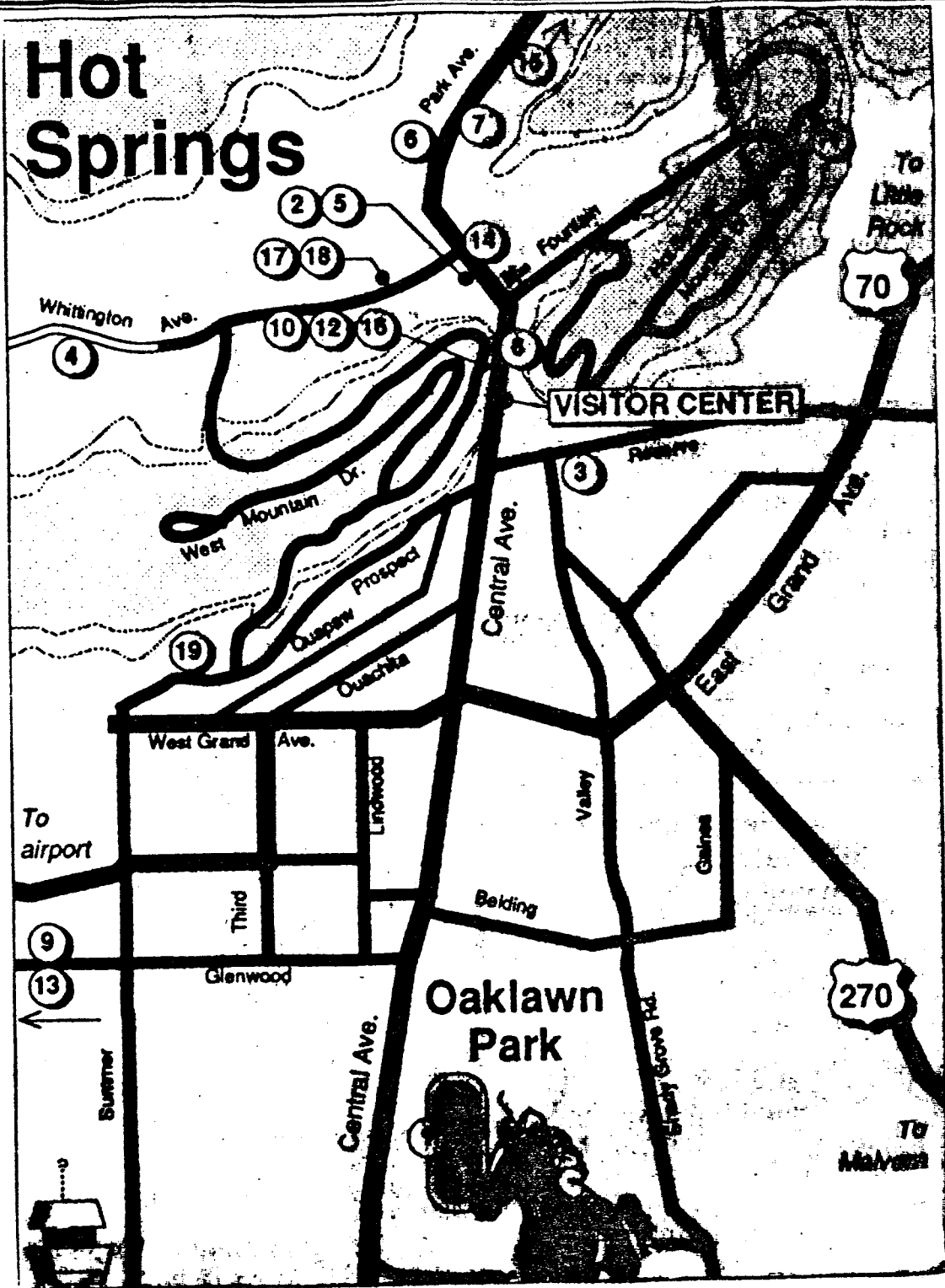

**ATTRACTIONS:**

- |                           |                           |                                |
|---------------------------|---------------------------|--------------------------------|
| 1. OAKLAWN PARK           | 7. ROCKY TOP JUBILEE      | 13. MUSIC MOUNTAIN JAMBOREE    |
| 2. TUSSAUD WAX MUSEUM     | 8. BATH HOUSE SHOW        | 14. NATIONAL PARK AQUARIUM     |
| 3. HOT SPRINGS HEALTH SPA | 9. MID-AMERICA MUSEUM     | 15. CASTLEBERRY RIDING STABLES |
| 4. ALLIGATOR FARM         | 10. I.Q. ZOO              | 16. REED'S MUSEUM OF AUTOS     |
| 5. MOUNTAIN VALLEY WATER  | 11. HOT SPRINGS MT. TOWER | 17. EDUCATED ANIMAL ZOO        |
| 6. AR-SCENIC SPRING       | 12. WHITE DUCKS TOURS     | 18. TINY TOWN                  |

# NATIONAL BASS ASSOCIATION OF THE DEAF

## ***BIG LUNKER CONTEST***

ON JUNE 15, MONDAY  
FROM 5:00 AM TO 11:00 AM

# \$1500

(BASED ON 100 ENTRIES)

1- \$600.00	4- \$112.50	7- \$52.50	10- \$30.00
2- \$300.00	5- \$75.00	8- \$45.00	11- \$22.50
3- \$150.00	6- \$60.00	9- \$37.50	12- \$15.00

BIG LUNKER CONTEST FEE PER PERSON: \$15.00

# NATIONAL BASS ASSOCIATION OF THE DEAF

## ***TEAM TOURNAMENT PRIZES***

ON JUNE 16, TUESDAY THROUGH JUNE 18, THURSDAY  
FROM 5:00 AM TO 3:00 PM

PLACE	TUESDAY, JUNE 16	WEDNESDAY, JUNE 17	THURSDAY, JUNE 18
1st	\$125 & 2 TROPHIES	\$125 & 2 TROPHIES	\$125 & 2 TROPHIES
2nd	\$100 & 2 TROPHIES	\$100 & 2 TROPHIES	\$100 & 2 TROPHIES
3rd	\$75 & 2 TROPHIES	\$75 & 2 TROPHIES	\$75 & 2 TROPHIES
LUNKER	\$50 & TROPHY	\$50 & TROPHY	\$50 & TROPHY

PLACE	FINAL 3 DAYS TOTAL
1st	\$2000 & 2 TROPHIES
2nd	\$\$\$ & 2 TROPHIES
3rd	\$\$\$ & 2 TROPHIES
RATIO 3-1	\$\$\$

## ***SPECIAL PRIZES***

1. \$610 - TO THE ANGLER FOR BREAKING NBAD'S LEADING LUNKER RECORD OF 7 pounds 11 ounces.
2. \$410 - TO THE ANGLER FOR BREAKING NBAD'S LEADING BASSMASTER RECORD OF 44 pounds 4 ounces.
3. \$410 - TO THE ANGLER FOR BREAKING NBAD'S LEADING TEAM CHAMPION RECORD OF 85 pounds 14 ounces.
4. \$\$\$\$ - TO THE ANGLER FOR LEADING THE LARGEST BASS LUNKER THROUGH THE 3-DAY TEAM TOURNAMENT.
5. \$\$\$\$ - TO THE ANGLER FOR LEADING BASSMASTER THROUGH THE 3-DAY TOTAL TEAM TOURNAMENT.

TOURNAMENT ENTRY FEE PER PERSON: \$50.00



# NATIONAL BASS ASSOCIATION OF THE DEAF

## 1992 SCHEDULE OF EVENTS

### JUNE 14, SUNDAY

8 AM

NBAD EXECUTIVE BOARD MEETING  
AT OFFICE AREA

1 PM to 5 PM

NBAD REGISTRATION  
AT LODGE CONFERENCE BUILDING

7 PM

COUNCIL OF REPRESENTATIVE MEETING  
AT LODGE CONFERENCE BUILDING

### JUNE 15, MONDAY

5 AM to 11 AM

BIG LUNKER CONTEST

8 AM to 11 AM

NBAD REGISTRATION

1 PM

AT LODGE CONFERENCE BUILDING

GENERAL ASSEMBLY (NO FISHING!)

BIDDING FOR TOURNAMENT SITES

PRESENTATION OF NBAD PATCHES TO ROOKIES

AT LODGE CONFERENCE BUILDING

6 PM to 8 PM

JR NBAD's FISHING DERBY

### JUNE 16, TUESDAY

5 AM to 3 PM

TEAM TOURNAMENT (DAY 1)

9 AM

FAMILY RECREATION

3 PM

WEIGH-IN

7 PM

ANNOUNCEMENT OF THE WINNERS:

1-2-3 PLACES & LUNKER

SOCIAL

AT LODGE CONFERENCE BUILDING

### JUNE 17, WEDNESDAY

5 AM to 3 PM

TEAM TOURNAMENT (DAY 2)

9 AM

FAMILY RECREATION

3 PM

WEIGH-IN

7 PM

ANNOUNCEMENT OF THE WINNERS:

1-2-3 PLACES & LUNKER

DOOR PRIZES

AT LODGE CONFERENCE BUILDING

### JUNE 18, THURSDAY

5 AM to 3 PM

TEAM TOURNAMENT (FINAL)

9 AM

FAMILY RECREATION

3 PM

WEIGH-IN

7 PM

ANNOUNCEMENT OF THE WINNERS:

1-2-3 PLACES & LUNKER

ANNOUNCEMENT OF TEAM CHAMPIONS,

SPORTSMANSHIP & BASSMASTER

AT LODGE CONFERENCE BUILDING

**1992**  
**NATIONAL BASS ASSOCIATION**  
**OF THE DEAF**  
**OFFICERS**

**PRESIDENT**  
ALAN D. RORK  
2011 ASHBOURNE ROAD  
ANDERSON, INDIANA 46011  
317-649-6309 (TDD)

**VICE-PRESIDENT**  
MARTIN H. MILLER  
56546 HOLLYWOOD BVD.  
SOUTH BEND, INDIANA 46619  
219-287-3753 (TDD)

**SECRETARY**  
ELEN ZOOK  
P.O. BOX 44  
WESTFIELD, INDIANA 46074  
317-773-5442 (TTD)

**TREASURER**  
JACK STIGERS  
4413 BRENDA DRIVE  
ANDERSON, INDIANA 46013  
317-642-5249 (TDD)

**PUBLICITY DIRECTOR**  
JOSEPH O. BROZ  
P.O. BOX 159  
ONLEY, VIRGINIA 23418-0159  
804-787-8937 (TDD)

**GENERAL CHAIRMAN**  
WILLIAM SCHWALL  
20 KINGSPARK COURT  
LITTLE ROCK, ARKANSAS 72207  
501-225-6415 (TDD)

---

---

---

---

# NATIONAL BASS ASSOCIATION OF THE DEAF TOURNAMENT ENTRY FORM

## SPECIAL ENTRY FEE COUPON - SAVE \$10.00

THE ENTRY FEE PER PERSON WILL BE \$50.00 WHICH WILL BE DUE ON OR BEFORE MAY 16, 1992. AFTER THAT DATE, IT WOULD BE \$60.00 AS THE LATE CHARGE AND WILL BE REQUIRED FOR YOU TO PAY THE CASH AT LAKE OUACHITA.

PLEASE MAKE PAYABLE TO NATIONAL BASS ASSOCIATION OF THE DEAF, INC. AND MAIL THE ENTRY FEE COUPON WITH THE MARKING ENCLOSED CHECK BEFORE MAY 16, 1992.

MAIL TO:

NATIONAL BASS ASSOCIATION OF THE DEAF  
C/O JACK STIGERS, NBAD TREASURER  
4413 BRENDA DRIVE  
ANDERSON, INDIANA 46013

ENCLOSED IS: (CHECK ONE)

- MONEY ORDER  
 CERTIFIED CHECK  
 PERSONNEL CHECK

NAME: \_\_\_\_\_ ADDRESS: \_\_\_\_\_

CITY: \_\_\_\_\_ STATE: \_\_\_\_\_ ZIP: \_\_\_\_\_

WILL YOU HAVE A PARTNER?  NO  YES, NAME: \_\_\_\_\_

WILL YOU BRING A BOAT?  YES  NO, PARTNER WILL BRING HIS/HER BOAT.  
 NO, I NEED A PARTNER IN HIS/HER BOAT.

ARE YOU A MEMBER OF THE AFFILIATED CLUB?  NO  YES, NAME: \_\_\_\_\_

NOTE: NO REFUND AFTER MAY 16, 1992

## LITTLE ROCK BASS ANGLERS OF THE DEAF, INC COMMITTEE MEMBERS

WILLIAM SCHWALL,  
GENERAL CHAIRMAN,  
501-225-6415 (TDD)

RONDALE KETCHUM,  
CO-CHAIRMAN,  
501-565-5117 (TDD)

MARTIN WEST,  
CORRESPONDING SECRETARY,  
501-967-4133 (TDD)

STANLEY KETCHUM,  
TREASURER,  
501-455-4652 (TDD)

CHARLES HELM,  
TROPHY CHAIRPERSON,  
501-568-1301 (TDD)

SANDRA SCHWALL,  
FAMILY RECREATION  
CHAIRPERSON,  
501-225-6415 (TDD)

DAVID KING,  
PRIZE PROJECT /  
PROGRAM BOOK  
CHAIRPERSON,  
501-255-5761 (TDD)

BRETT KETCHUM,  
WEIGH-IN  
CHAIRPERSON,  
501-888-5352 (TDD)

KEITH JAMES,  
BOAT INSPECTION  
CHAIRPERSON,  
501-557-2859 (TDD)

KRISTY SCHWALL, INTERPRETER, 501-565-1733 (VOICE)