

NBAD TACKLE BOX

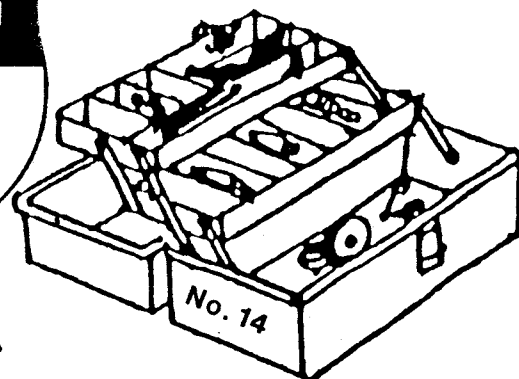
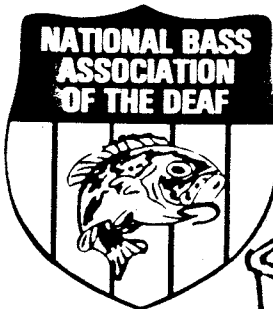

Vol. 14 No. 2

NATIONAL BASS ASSOCIATION OF THE DEAF

September 1992

Every thing is in it or it isn't Bass News

17th Annual NBAD Team Tournament at Lake Ouachita in Arkansas on June 16, 17, 18, 1992

BIG NBAD LIFE at LAKE OUACHITA

Howdy, ya all readers!...While, in an old Southern way, sitting on an old stump next to the fishing pond surrounding with all unspoiled natural botanical evergreens, I am trying to catch some huge Redear breems with my old faithful bamboo pole. Seeing that pretty fishing pond made me reminding about something big in the life. I mean a big one, called a BIG NBAD LIFE at LAKE OUACHITA in "THE NATURAL STATE", Arkansas. Hmmm. Let me tell you about...

.....THAT 17th Annual National Bass Association of the Deaf Team Tournament during the second week of June directed by General Chairman W.O. Schwall and Co-Chairman/LRBAD President Rondale Ketchum at Mountain Harbor resort located by Lake Ouachita as known a largest lake in Arkansas, sponsored by our club, Little Rock Bass Anglers of Deaf, Inc. Let me talk about day-to-day activity happens during that special NBAD week. As an opening day of Saturday, June 13th in the beautiful

weather condition, We, all members of LRBAD and staff employees of Mountain Harbor resort, bade our honorable welcomes to all NBAD President Alan D. Rork, NBAD Officers, anglers, families, friends, quests, and fans to the beautiful Mountain Harbor resort included the finest Game and Fish Commission Aquarium Special Weight - in stand, and Tour to Hot Springs. Most of them were arrived in the resort and made a lot of remarkable times with many surprises, greetings, huggings each other. Sure enough, most of anglers so excited got their boats into the lake immediately and went out for some countless hours of serious practices after their arrivals. Still, they had earned their opportunities to see the real unspoiled wilderness around the lake. Their practices were last only two days before the coming Big Lunker Contest was provided by our club. LRBAD. At the evening, there was a Council of Representative meeting with all representatives from all different affiliated clubs under NBAD at Lodge Conference' Building, proceed by NBAD President Alan
(Continued to page 3)

NBAD TACKLE BOX

is the official
publication of

NATIONAL BASS ASSOCIATION
OF THE DEAF

The publication is
published twice a
year in March and
September.



Founded 1976
Incorporated 1988

Founder
Robert Southwell
Past Founder
Anthony W. Mowad

1992-1993

PRESIDENT

Alan D. Rork
2011 Ashbourne Road
Anderson, IN 46011
TTY 317/649-6309

VICE PRESIDENT

Martin H. Miller
56546 Hollywood Boulevard
South Bend, IN 46619
TTY 219/287-3753

SECRETARY

Elen Rork Zook
P.O. Box 44
Westfield, IN 46074
TTY 317/773-5442

TREASURER

Jack Stigers
4413 Brenda Drive
Anderson, IN 46013
TTY 317/642-3022

PUBLICITY DIRECTOR

Wesley Parsons
P.O. Box 574
Cheektowaga, NY 14225
TTY 716/822-8037

LIFETIME EXECUTIVE

Robert Southwell
Rt. 3, Box 183
Ville Platte, LA 70586
TTY 318/461-2255

EXECUTIVE BOARD

Charles E. Marsh, Jr.
1063 Ashbury Street
Olathe, KS 66061
TTY 913/782-6643

Copyright 1993

Subscription rate
is \$5.00 a year.

Notes from Publicity Director

1979

State

David Chamagne, _____
Dell Cholson, _____
Carlos Flarup, _____
Luther Green, _____
Robert Harper, _____
John Melance, _____
Mark Philip, _____
Wayne Schatter, _____

1987

State

S. Brown, _____
(Also give his first name)
Sonny Johnson, _____
Andrew Leland, _____

This year the Publicity Director has sometimes spent his time checking names of the anglers who participated in the NBAD's annual tournaments and he realizes he needs your help to find out where those anglers came from. After you have found out and fill out below where one or more anglers live and mail it to him as soon as possible. It is very urgent for you to do that because time is really short between now and 1995. So that the chairman of the 20th Annual NBAD Team Tournament will have everything in a program book or history book ready for an event in 1995.

The NBAD will appreciate greatly your cooperation and assistance. Thank you.

Here is a list of names of anglers who participated in 1979 and 1987 below:

IN MEMORY OF JOSEPH O. BROZ

We experienced a great sorrow with the loss of Joseph O. Broz. Joseph, 68, passed away on February 20, 1992. His sudden death was caused by brain hemorrhage without prolonged pain. He was publicity director for three years, keep statistics for NBAD History/Records, and published the NBAD Tackle Box Newsletter twice per year. He also made it possible to order NBAD products from your homes. His excellent work for NBAD was greatly honored by NBAD boards and members, and his friendly personality will be missed by all of us.

NBADfully,

Alan D. Rork

Alan D. Rork
NBAD President

(Continued from page 1)

D.Rork from Indiana. Bill Barnes, general manager and Pati Brown, lodge manager were invited to bid NBAD their opening welcome ceremony to the Mountain Harbor resort.

Bass Lunker Contest

For the morning time of Monday, June 15th for the Big Lunker Contest day, W.O. Schwall from Arkansas captured the first place leading with a big bass weighed 4.18 pounds and took home \$670. All prize money went to the rest from second to twelfth. in that afternoon time after that contest, there was again a General Meeting at lodge Conference Building, proceed by NBAD President Alan Rork for bidding for tournament sites and presentation of NBAD patches to rookies During the meeting, President Alan Rork announced that there were total 146 anglers Participating in the 1992 NBAD Team Tournament after the final closed registration. After that meeting was adjourned, there was a very special event, which is called Jr.NBAD's Fishing Derby, for the kids with parental guidances to catch any kind of fish. Surprised, many kids had their unforgotten pleasures of fishing and had brought many breams in for the weight-ins. Many Beautiful trophies were presented to several kids.

TEAM TOURNAMENT (DAY 1)

In the opening first day of Tuesday, June 16th, Joe Wilson and Ronald Smith from Missouri came out for the first place with 16 bass weighed 23.49 pounds. Second place went to Patrick Ferguson and Roger Kays from Oklahoma with 11 bass weighed 15.88 pounds. Thrid place went to Danny Cochran and Charles Penland from Tennessee with 8 bass weighed 9.56 pounds. Dennis Bacon from Missouri. formerly 1987 NBAD Champ at Lake Kentucky, had brought in a big bass weighed 4.28 pounds and took a lead for the big bass record. At the late afternoon time after the first day

tournament, the ranger from the Arkansas Game and Fish Commission gave an interested lecture about the natural wildlife at Lake Ouachita. At the evening time, All prize money and trophies were presented to the top 3-team and big lunker winners.

TEAM TOURNAMENT (DAY 2)

In the next second day of Wednesday, June 17th, Joe Wilson and Ronald Smith from Missouri again came out for the first place with 15 bass weighed 23.88 pounds. Also, second place went to Patrick Ferguson and Roger Kays from Oklahoma again with 5 bass weighed 13.21 pounds. Third place went to Norman Walker from Louisiana and Phillip Huckaby from Tennessee with 10 bass weighed 12.87 pounds. Patrick Ferguson had swung in a bigger bass weighed 6.41 pounds and got a step over Dennis Bacon's big bass leading record After that second day tournament, Bobby Murray, retired professional bass angler and formally won the first Bass Master Classic in 1971 at Lake Mead, Nevada, also gave a superb lecture and instruction of how to fish in the proper way in Lake Ouachita. At the evening time, All prize money and trophies were presented to the top 3-team and big lunker winners.

TEAM TOURNAMENT (FINAL)

The date of Thursday, June 18th was logged as the final day of the NBAD Team Tournament. Jerry Belew and David King from Arkansas formerly 1986 NBAD Champs at Bull Shoals Lake, came out for the first place with 7 bass weighed 18.08 pounds. Second place went to Keith James from Arkansas and Gene Amons from Louisian, formerly 4 times NBAD champs, with 10 bass weighed 15.45 pounds. Third place went to Norman Walker from Louisiana and Phillip Huckaby from Tennessee with 8 bass weighed 9.74 pounds. New biggest shock had came to all anglers and fans to see a biggest bass that Jerry

(Continued from page 3)

Belew had brought in. Jerry looked so nervous! It was finally weighed to be 9.07 pounds. Patrick Ferguson's big bass leading record was climbed down to second and Dennis Bacon's to third. All prize money and trophies were presented to them at the evening time. At the special evening in the same date, Jerry Belew and David King from Arkansas came in for the third place overall leads with 13 bass weighed 25.83 pounds and accepted \$750 in prize money and trophies. Patrick Ferguson and Roger Kays from Oklahoma also came in for the second place overall leads with 17 bass weighed 30 pounds and earned \$1000 in prize money and trophies. Joe Wilson and Ronald Smith from Missouri captured the new 1992 National Bass Association Team Tournament championships with 37 bass weighed 53.45 pounds and collected \$2000 in prize money and trophies. All prize money were presented to the rest from fourth to twenty-seventh after the first 3 teams. The Mowad Sportsmanship Award went to Karl Nygaard from Wisconsin. The Southwell Bassmaster Award went to Ronald Smith from Missouri with the leading heavy stringer of 21 bass weighed 33.49 pounds. The Award of Largest Bass Lunker through the 3-day Team Tournament went to Jerry Belew from Arkansas with 9.07 pounds. He also set the new NBAD official record of 9.07 pounds over the 16 year record of 7.11 pounds, that was caught by Late John Cloy from Louisiana, and again collected \$556. Bill Barnes and Pati Brown were presented the LRBAD Award by General Chairman W.O.Schwall for appreciating them and their great timeless supports to little Rock Bass Anglers of the Deaf during the NBAD week. A BIG thanks thanks went to Kristy Schwall for her great countless support as an interpreter.

At the last day of Friday, June 19th, We, all members of LRBAD and staff employees of Mountain Harbor Resort, Bade our big farewells to all who were leaving Arkansas for heading home with their great memories, include a special honorable memory of Joseph o. Broz, who was passed away on February 20, 1992.

Ahh!, that was a big NBAD life
.....have a Good Fishing day!--

--Martin West, Arkansas

ROOKIE'S REPORT

As I arrived at the Mountain Resort near Hot springs, Arkansas, where the National Bass Association of the Deaf had their tournament, I was impressed with the welcome I received from the officials and the friendliness of the members.

Especially in meeting my former classmate Bill Schwall, the tournament's chairman, for the first time in thirty-five years added to my enjoyment be there.

My esteem of the people, I met didn't change. When the weather was hot and windy, the bass were there but not co-operating and weren't hitting too well. I wished that I had a chance to join N.B.A.D. years ago. I know I can't change the clock back, but I looking forward associating with the members again.

Also, I am glad that I bought an N.B.A.D. cap or else I would have become brain-fried in that Hot Arkansas Killer sun. I was pleased that the ladies kept the iced-tea flowing, I must have drank over two gallons, sorry to report that no tea leaves are growing out of my ears.

Once again, many thanks for the warmest welcome I received. Keep up the god work and wish N.B.A.D. many more successful tournaments.

-- Ed Bastian, Buffalo, N.Y.

17th Annual NBAD Team Tournament
Lake Ouachita, Arkansas
June 16, 17, 18, 1992

List of Participants

1. Alderman, Loren
2. Amons, Gene
3. Anderson, John
4. Andrusejko, Richard
5. Ashley, James
6. Bacon, Dennis
7. Baker, Bill
8. Barnett, Bill
9. Bastian, Edward
10. Belew, Jerry
11. Bitner, William
12. Bledsoe, Billy
13. Blosskas, John
14. Borders, Ralph
15. Braun, Robert
16. Brown Rudy
17. Bruce, John
18. Byrns, Mike
19. Callahan Jr., William
20. Carnes, Douglas
21. Carrizales, Jesse C.
22. Carrizales Jr., Juan
23. Chapman, Bill
24. Cherry, Alan
25. Clark, Tony
26. Coager, Glen
27. Cochran, Danny
28. Cole, Carmon
29. Coggins, John
30. Collins, Billie
31. Collins, Connie
32. Conway, Homer
33. Cooper, Ricky
34. Davis, Thomas F.
35. Davis Jr., Waldo
36. Delvisco, Ronnie
37. Dickman, Daniel
38. Dornacker, Kenneth
39. Eakins, Bobby
40. Eates, Tom
41. Elmer, Leroy
42. Embree, Lloyd
43. Ferguson, Patrick
44. Fewell, Larry
45. Frisky, Terry
46. Fuller, Johnny
47. Garcia, Abel
48. Gentry, David
49. Giffin, Larry
50. Gilmore, Marion
51. Granger, Dale
52. Hallmark, B.R.
53. Hancock, Doyle
54. Harris, Arthur
55. Harvard, Hayden
56. Harvard, Henry
57. Hickman, Tom
58. Holdridge, Carlos
59. Holle Sr., Richard
60. Huckaby, Philip
61. Ingram Jr., Charles
62. James, Keith
63. Kays Jr., Roger
64. Keinath, David
65. Keinath, Warren
66. Ketchum, Brett
67. Ketchum, Edward
68. Ketchum, Ronald
69. Ketchum, Stanley
70. King, David
71. Kristner, Kenneth
72. Lange, Aaron
73. Larkin, Winfred
74. Long, Edgar
75. Long, Virginia
76. Love, Bobby
77. Love, Joe K.
78. Magill, Medford
79. Marsh Jr., Charles
80. Mart, Wayne
81. Mikus Sr., Jerry
82. Miller, Martin
83. Miller, Robert
84. Morris, Steve
85. Mueller, Glenn
86. Murphree, Charles
87. Myers, Richard
88. McClintock, Raymond
89. McClintock, Thomas
90. McNew, Gerald
91. McKnatt, Ernest
92. Neill, Walter
93. Nygaard, Karl
94. Parsons, Wesley A.
95. Peckman,
96. Penland, Charles W.
97. Pennington, Bill
98. Porter, Morris
99. Poteat, Randolph
100. Randall, Raymond
101. Randall, Margie
102. Richardson, Larry
103. Riley, William
104. Rivers, Stanley
105. Robert, Randy
106. Rodgers, Thomas
107. Rogers, Thomas
108. Roak, Alan D.
109. Santens, Barry
110. Saulman, Ricky
111. Schaeffee, Ricky
112. Schaeffee, Wayne
113. Schirmer, Glenn
114. Schrier, Terry
115. Schumacher, Chester
116. Schwall, Walter
117. Schwall, William
118. Scott, Joel
119. Shiver, Joel
120. Sheffield, Harry
121. Smith, Ronald
122. Smith, Kevin
123. Southwell, Robert
124. Spivey, Roger
125. Stanford, Ronald
126. Stehle, Kenneth
127. Stigers, Jack
128. Stuckey, Patrick
129. Styn, James
130. Styn, Ricky
131. Surber, John
132. Vaznonis, Leonard
133. Walker, Norman
134. Weigand, Jerry
135. Wentz, Dale
136. West, Martin
137. White, Edwin
138. Williams, Billy
139. Williams, Clovis
140. Wilson, Joe
141. Wilson, Mack
142. Wolnitzek, Harold
143. Wood, Edward P.
144. Worth, Calus
145. Wyllia, Jackie
146. Zeigler, Jack R.
147. Zook, Jack

17th Annual NBAD Team Tournament
Lake Ouachita, Arkansas
June 16, 17, 18, 1992

List of Rookies

1. Barnett, Bill, Kansas
2. Bastian, Edward L., New York
3. Bloskas Jr., John, Texas
4. Bruce, John, Louisiana
5. Callahan Jr., William, Tennessee
6. Conway, Homer E., Missouri
7. Fuller, Johnny M., Tennessee
8. Giffin, Larry, Ohio
9. Hockaby, Philip D., Tennessee
10. McKnott, Ernest, Tennessee
11. McNew, Gerald, Arkansas
12. Richardson, Larry, Arkansas
13. Rivers, Stanley, Oklahoma
14. Saulman, Ricky, North Carolina
15. Schwall, Walter, Arkansas
16. Shiver, Joel, Missouri
17. Styn Sr., James, Arkansas
18. Styn, Ricky, Arkansas

10 States

1. Arkansas ----- 5
2. Kansas ----- 1
3. Louisiana ----- 1
4. Missouri ----- 2
5. New York ----- 1
6. North Carolina 1
7. Ohio ----- 1
8. Oklahoma ----- 1
9. Tennessee ----- 4
10. Texas ----- 1

17th Annual NBAD Team Tournament
Lake Ouachita, Mount Ida, Arkansas
June 16, 17, 18, 1992

Tournament Results

1st Day - Tuesday, June 16th

- 1st - 23.49 lbs. - 11A-Joe Wilson, Mo. and 11B-Ronald Smith, Mo.
(11.37 lbs.)(8) (12.12 lbs.)(8)
- 2nd - 15.88 lbs. - 12A- Patrick Ferguson, Ok. and 12B- Roger Kays, Ok.
(7.52 lbs.)(3) (8.36 lbs.)(8)
- 3th - 9.56 lbs. - 24A- Danny Cochran, Tn. and 24B- Charles Penland, Ga.
(7.13 lbs.)(6) (2.43 lbs.)(2)
- Lunker of the Day - 37B- 4.28 lbs. - Dennis Bacon. Mo.

2nd Day - Wednesday, June 17th

- 1st - 23.88 lbs. - 11A- Joe Wilson, Mo. and 11B- Ronald Smith, Mo.
(7.69 lbs.)(7) (16.19 lbs.)(8)
- 2nd - 13.21 lbs. - 12A- Patrick Ferguson, Ok. and 12B- Roger Kay, Ok.
(8.05 lbs.)(2) (5.16 lbs.)(3)
- 3th - 12.87 lbs. - 59A-Norman Walker, La. and 59B- Philip Huckaby, Tn.
(6.83 lbs.)(6) (6.04 lbs.)(4)
- Lunker of the Day - 12A- 6.41 lbs. - Patrick Ferguson, Ok.

3th Day - Thursday, June 18th

- 1st - 18.08 lbs. - 46A- Jerry Belew, Ar. and 46B- David King, Ar.
(12.74 lbs.)(3) (5.34 lbs.)(4)
- 2nd - 15.45 lbs. - 10A- Keith James, Ar. and 10B- Gene Amons, La.
(8.52 lbs.)(5) (6.93 lbs.)(5)
- 3th - 9.74 lbs. - 59A- Norman Walker, La. and 59B- Philip Huckaby, Tn.
(7.94 lbs.)(6) (1.80 lbs.)(2)
- Lunker of the Day - 46A- 9.07 lbs. - Jerry Belew, Ar.

Bassmaster Award Winner - Ronald Smith, Mo. 21 bass 33.49 lbs.

Sportsmanship Award Winner - Karl Nygaard, Wisconsin

Best Lunker of the Tournament - 9.07 lbs. - Jerry Belew, Arkansas

New Record - 9.07 lbs and Old Record - 7 lbs.11 oz.
Jerry Belew John Cloy

1992- ARK.

Boat No. and Partner Names	3 Days Wgt	Place
11 A Joe Wilson (MO)	19.96	
11 B Ronald Smith (MO)	33.49	
	53.45	1
12 A Patrick Ferguson (OK)	15.57	
12 B Roger Kays, Jr. (OK)	14.43	
	30.00	2
46 A Jerry Belew (AR)	20.49	
46 B David King (AR)	5.34	
	25.83	3
59 A Norman Walker (LA)	17.19	
59 B Phillip Huckaby (TN)	7.84	
	25.03	4
10 A Keith James (AR)	10.49	
10 B Gene Amons (LA)	13.66	
	24.15	5
24 A Danny Cochran (TN)	16.23	
24 B Charles Penland (GA)	2.43	
	18.66	6
23 A Ron Stanford (OK)	9.08	
23 B Robert Miller (OK)	7.79	
	16.87	7
62 A Morris Porter (TX)	14.39	
62 B Charles Murphree (TX)	1.63	
	16.02	8
37 A Stanley Rivers (OK)	3.62	
37 B Dennis Bacon (MO)	11.50	
	15.12	9
70 A Ricky Saulman (NC)	2.52	
70 B Randy Poteat (NC)	11.35	
	13.87	10
52 A Ricky Cooper (GA)	8.90	
52 B Charles Ingram (GA)	3.73	
	12.63	11
9 A Rondale Ketchum (AR)	9.79	
9 B Stanley Ketchum (AR)	2.48	
	12.27	12
28 A Dale Granger (LA)	8.64	
28 B Kevin Smith (SA)	3.28	
	11.92	13
43 A Ed Wood (LA)	5.53	
43 B Medford Magill (LA)	5.44	
	10.97	14
41 A Henry Harvard (TX)	9.96	
41 B Hayden Harvard (TX)	0	
	9.96	15
53 A Larry Fewell (TX)	4.34	
53 B Roger Spivey (TX)	4.90	
	9.24	16
7 A Edward Ketchum (AR)	1.86	
7 B Brett Ketchum (AR)	6.34	
	8.20	17
13 A Warren Keinath (MO)	5.46	
13 B David Keinath (MO)	2.60	
	8.06	18

1992-ARL.

Boat No.	Partner Names	3 Days Wgt.	Place
50 A	Kenneth Stehle (MO)	5.67	
50 B	Ray McClintock (MO)	2.23	
		7.90	19
68 A	Ronald Delvisto (LA)	5.20	
68 B	Rudy Brown (LA)	2.50	
		7.70	20
1 A	Alan Rork (IN)	2.92	
1 B	Mike Byrns (IN)	4.63	
		7.55	21
6 A	William Schwall (AR)	4.92	
6 B	Walter Schwall (AR)	2.42	
		7.34	22
39 A	Dale Wentz (MO)	1.48	
39 B	Thomas F. Davis (MO)	5.38	
		6.86	23
60 A	Daniel Dickman (MO)	4.54	
60 B	Kenneth Kistner (MO)	2.25	
		6.79	24
19 A	Bobby Eakins (MO)	5.90	
19 B	Clovis Williams (MO)	.77	
		6.67	25
55 A	Glen Mueller (MO)	3.00	
55 B	Tom McClintock (MO)	3.61	
		6.61	26
33 A	James Styn (AR)	2.72	
33 B	Ricky Styn (AR)	3.65	
		6.37	27
21 A	Wayne Mart (FL)	0	
21 B	Terry Frisky (FL)	6.36	
		6.36	28
49 A	Thomas Hickman (IN)	1.97	
49 B	Connis Collins (IN)	4.00	
		5.97	29
3 A	Jack Stigers (IN)	1.48	
3 B	Jack Zook (IN)	4.37	
		5.85	30
61 A	Carlos Holdridge (TX)	3.82	
61 B	Billie Collins (TX)	1.23	
		5.05	31
34 A	William Riley (TN)	0	
34 B	William Callahan, Jr. (TN)	4.77	
		4.77	32
48 A	Ricky Schaeffer (AR)	0	
48 B	Wayne Schaeffer (AR)	4.42	
		4.42	33
4 A	Bill Chapman (OK)	4.39	
4 B	Robert Southwell (LA)	0	
		4.39	34
18 A	Arthur Harris (AR)	.87	
18 B	Larry Richardson (AR)	3.41	
		4.28	35
16 A	William Bitner (WY)	3.87	
16 B	Terry Schrier (MO)	0	
		3.87	36

1992-ARK.

Boat No. and Partner Names	3 Days Wgt.	Place
31 A Richard Andrusejko (MO)	1.89	
31 B John Bruce (MO)	1.68	
	3.57	37
69 A Billy Bledsoe (NC)	3.52	
69 B Steve Morris/John Surber (NC/MO)	0	
	3.52	38
38 A James Ashley (TX)	3.34	
38 B John Coggins-Peckman (TX)	0	
	3.34	39
36 A Bill Baker (TN)	0	
36 B Johnny Fuller (TN)	2.67	
	2.67	40
58 A Jerry Mikus (TX)	0	
58 B Glen Coager (TX)	2.65	
	2.65	41
15 A Alan Cherry (WI)	0	
15 B Carmon Cole (WI)	2.45	
	2.45	42
54 A Jesse Carrizales (TX)	2.40	
54 B Juan Carrizales (TX)	0	
	2.40	43
40 A Marion Gilmore (OH)	2.34	
40 B Jack Zeigler/Joe K. Love (OH/OH)	0	
	2.34	44
5 A Charles Marsh (KS)	1.07	
5 B Karl Nygaard (WI)	1.18	
	2.25	45
25 A Aaron Lange (MO)	1.42	
25 B Mack Wilson (MO)	.81	
	2.23	46
64 A Abel Garcia (TX)	0	
64 B B. R. Hallmark (TX)	2.03	
	2.03	47
65 A David Gentry (TX)	1.78	
65 B John Bloskas, Jr. (TX)	0	
	1.78	48
20 A Joel Shiver (MO)	1.72	
20 B Tony Clark (MO)	0	
	1.72	49
56 A John Embree (IL)	0	
56 B Leonard Vaznonis (IL)	1.52	
	1.52	50
17 A Wesley Parsons (NY)	0	
17 B Ed Bastian (NY)	1.39	
	1.39	51
22 A Tom Rogers (OH)	1.34	
22 B Waldo Davis (OH)	0	
	1.34	52
42 A Barry Santens (MO)	1.34	
42 B Homer Conway (MO)	0	
	1.34	52
63 A Randy Roberts (AR)	1.34	
63 B Edwin White (AR)	0	
	1.34	52

1992 - ARK.

Boat No. and Partner Names	3 Days Wgt.	Place
71 A Walter Neill (KS)	1.23	
71 B Bill Barrett (KS)	0	
	1.23	53
66 A Patrick Stuckey (TX)	0	
66 B Winfred Larkin (IN)	1.08	
	1.08	54
14 A Chester Schumacker (OH)	.93	
14 B Ralph Borders (OH)	0	
	.93	55
26 A Douglas Carnes (OK)	.82	
26 B Calus Worth (OK)	0	
	.82	56
35 A Kenneth Dornacker (WI)	.80	
35 B Loren Alderman (MN)	0	
	.80	57
44 A Leroy Elmer (WI)	0	
44 B John Anderson (WI)	.75	
	.75	58
2 A Richard Holle (IN)	0	
2 B Martin Miller (IN)	0	
8 A Martin West (AR)	0	
8 B Billy Williams (AR)	0	
27 A Gerald McNew (AR)	0	
27 B Robert Braun (OH)	0	
29 A Edgar Long (MO)	0	
29 B Virginia Long (M)	0	
30 A Richard Myers (OH)	0	
30 B Larry Giffin (OH)	0	
32 A Harold Wolnitzek (OH)	0	
32 B Harry Sheffield (KY)	0	
45 A Bill Pennington (AR)	0	
45 B Bobby Love (AR)	0	
47 A Joel Scott (TN)	0	
47 B Ernest McKnatt (TN)	0	
51 A Jerry Weigand (WI)	0	
51 B Glen Schirmer (WI)	0	
57 A Tom Eates (KS)	0	
57 B Thomas Rodgers (KS)	0	
67 A Ray Randall (OH)	0	
67 B Margie Randall (OH)	0	

No boat -- Doyle Hancock and Jackie Wyllia

Team Winners of the Day

1st Day
Tuesday, June 16, 1992



First Place Team

Left to right:

Ronald Smith, Mo. (12.12 lbs.)(8)

Joe Wilson, Mo. (11.37 lbs.)(8)



Second Place Team

Left to Right:

Roger Kays, Ko. (8.36 lbs.)(8)

Patrick Ferguson, Ok. (7.52 lbs.)(3)



Third Place Team

Left to right:

Danny Cochran, Tn. (7.13 lbs.)(6)

Charles Penland, Ga. (2.43 lbs.)(2)

Team Winners of the Day

2nd Day
Wednesday, June 17, 1992



First Place Team

Left to right:

Ronald Smith, Mo. (16.19 lbs.)(8)

Joe Wilson, Mo. (7.69 lbs.)(7)



Second Place Team

Left to right:

Patrick Ferguson, Ok. (8.05 lbs.)(2)

Roger Kays, Ok. (5.16 lbs.)(3)



Third Place Team

Left to right:

Norman Walker, La. (6.83 lbs.)(6)

Philip Huckaby, Tn. (6.04 lbs.)(4)

Team Winners of the Day

3rd Day

Thursday, June 18, 1992



First Place Team

Left to right:

David King, Ar. (5.34 lbs.)(4)

Jerry Belew, Ar. (12.74 lbs.)(3)

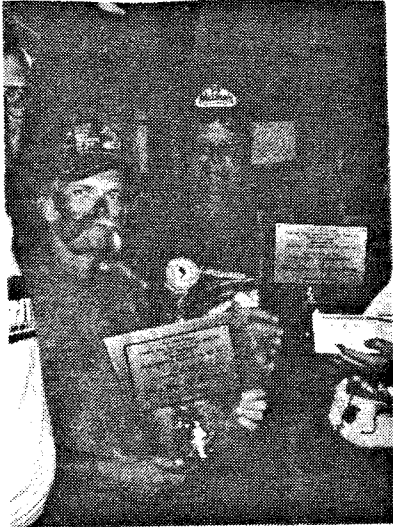

Second Place Team

Left to right:

Keith James, Ar. (8.52 lbs.)(5)

Gene Amons, La. (6.93 lbs.)(5)

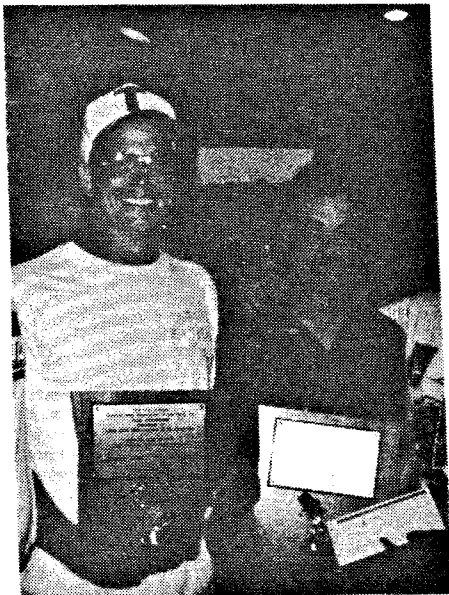

Third Place Team

Left to right:

Philip Huckaby, Tn. (1.80 lbs.)(2)

Norman Walker, La. (7.94 lbs.)(6)

Lunker Winner of the Day



1st Day Tuesday, June 16, 1992

Left to right:
William Schwall, General Chairman
Dennis Bacon, Mo. 4.28 lbs.
Alan D. Rork, President

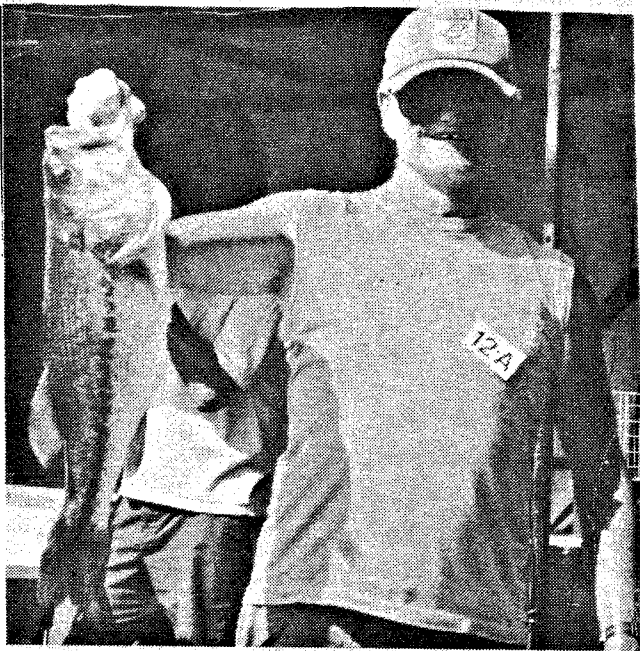

2nd Day Wednesday, June 17, 1992

Patrick Ferguson, Oklahoma
6.41 lbs.



3rd Day Thursday, June 18, 1992

Jerry Belew, Arkansas
BIG 9.07 lbs.

Award Winners



Bassmaster

Left to right:
Ronald Smith, Mo. 21 bass 33.49 lbs.
Robert E. Southwell, Founder



Sportsmanship

Left to right:
Karl Nygaard, Wisconsin
Alan D. Rork, President

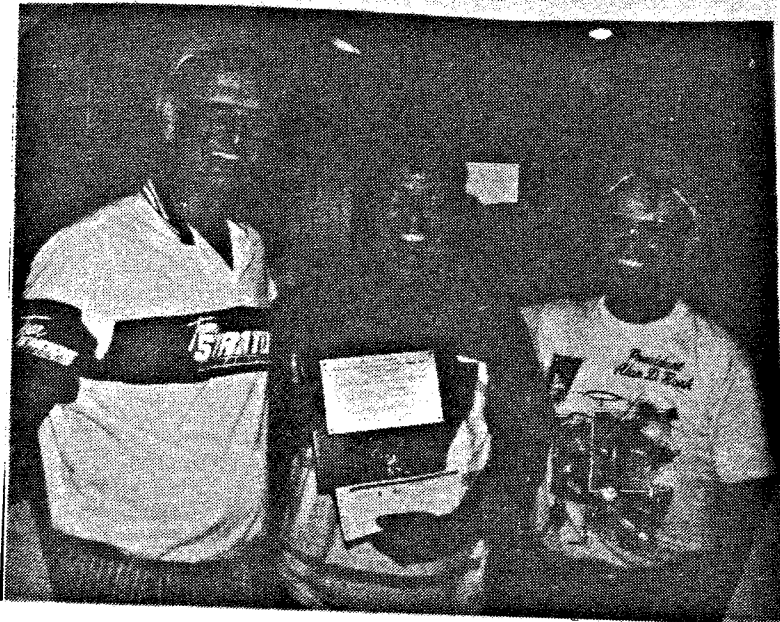

Lunker of the Tourney

Left to right:
William Schwall, General Chairman
Jerry Belew, Ar. BIG 9.07 lbs.
Alan D. Rork, President

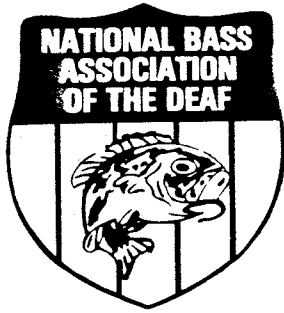

National Bass Association of the Deaf, Inc.

Founded by Robert Southwell & the Late Anthony Mowad at Toledo Bend, LA in 1976

To all affiliated club members:

Some of our members had tried to make reservations at West Point Lake and a letter came back that they could not make reservations until January 1, 1993.

Winfred Larkin and I called the resort on June 28, 1992 (Sunday) and talked with the resort manager. The resort has changed owners. Therefore, the person whom Winfred Larkin had spoken with during the spring vacation was no longer there. That person had told Winfred that reservations would be accepted by our NBAD group. And we reported this at the NBAD meeting, that the resort would accept your reservations now.

This is no longer true. In our telephone conversation, they said this was creating too much of a bookkeeping problem and they did not know what the rates will be for next year. The rates, I'm sure, will be increased next year. They want everyone to wait until January 1, 1993 to make reservations. They are excited about our tournament being there and want to accommodate our NBAD group, but for fairness to everyone and for their own bookkeeping records, they really need everyone to cooperate and wait until January. Winfred, Jack and I plan to go back in October to visit the resort.

So for right now, PLEASE HOLD THOSE RESERVATIONS until January 1. We are sorry if this has caused anyone inconvenience. Please be patient. A few reservations had been accepted under the old owner and will still be honored, but no more until January 1st, Please.

For any more information please contact Chairperson Winfred Larkin, 9509 Meadowlark Drive, Indianapolis, IN 46236, TTY 317-897-3735.

Sincerely yours,

Elen Zook
IBAD/NBAD Tournament Secretary

1992-1993

PRESIDENT

Alan D. Rork
2011 Ashbourne Road
Anderson, IN 46011
TTY 317/649-6309

VICE PRESIDENT

Martin H. Miller
56546 Hollywood Boulevard
South Bend, IN 46619
TTY 219/287-3753

SECRETARY

Elen Rork Zook
P.O. Box 44
Westfield, IN 46074
TTY 317/773-5442

TREASURER

Jack Stigers
4413 Brenda Drive
Anderson, IN 46013
TTY 317/642-3022

PUBLICITY DIRECTOR

Wesley Parsons
P.O. Box 574
Cheektowaga, NY 14225
TTY 716/822-8037

LIFETIME EXECUTIVE

Robert Southwell
Rt. 3, Box 183
Ville Platte, LA 70586
TTY 318/461-2255

EXECUTIVE BOARD

Charles E. Marsh, Jr.
1063 Ashbury Street
Olathe, KS 66061
TTY 913/782-6643

1993 TOURNAMENT GENERAL CHAIRMAN

Winfred Larkin
9509 Meadowlark Drive
Indianapolis, IN 46236
TTY 317/897-3735

1994 TOURNAMENT GENERAL CHAIRMAN

Edgar J. Long
2270 Calle Vista Dr.
Florissant, MO 63031
TTY 314/838-3883

1976 Toledo Bend, LA
1977 Toledo Bend, TX
1978 Table Rock, MO
1979 Toledo Bend, TX
1980 Lake Eufaula, AL
1981 Lake Livingston, TX
1982 Lake Eufaula, AL
1983 Lake Eufaula, OK
1984 Kentucky Lake, KY
1985 Toledo Bend, TX
1986 Bull Shoals, AR
1987 Kentucky Lake, KY
1988 Truman Lake, MO
1989 Lake Barkley, KY
1990 Sam Rayburn, TX
1991 Kentucky Lake, KY
1992 Lake Ouachita, AR
1993 West Point Lake, GA
1994 Table Rock, MO
1995 Lake Okeechobee, FL
1996 Truman Lake, MO
1997 Western States Region
1998 Center Hill, TN
1999 Central States Region



National Bass Association of the Deaf, Inc.

Founded by Robert Southwell & the Late Anthony Mowad at Toledo Bend, LA in 1976

July 6, 1992

To all affiliated club members:

1991-1992

PRESIDENT

Alan D. Rork
2011 Ashbourne Road
Anderson, IN 46011
TTY 317/649-6309

VICE PRESIDENT

Martin H. Miller
56546 Hollywood Boulevard
South Bend, IN 46619
TTY 219/287-3753

SECRETARY

Elen Rork Zook
P.O. Box 44
Westfield, IN 46074
TTY 317/773-5442

TREASURER

Jack Stigers
4413 Brenda Drive
Anderson, IN 46013
TTY 317/642-5249

PUBLICITY DIRECTOR

Joseph O. Broz
P.O. Box 159
Onley, VA 23418-0159
TTY 804/787-8937

LIFETIME EXECUTIVE

Robert Southwell
Rt. 3, Box 183
Ville Platte, LA 70586
TTY 318/461-2255

EXECUTIVE BOARD

Charles E. Marsh, Jr.
1063 Ashbury Street
Olathe, KS 66061
TTY 913/782-6643

**1992 TOURNAMENT
GENERAL CHAIRMAN**

William Schwall
20 Kingsport Ct.
Little Rock, AR 72207
TTY 501/225-6415

**1993 TOURNAMENT
GENERAL CHAIRMAN**

Winfred Larkin
9509 Meadowlark Drive
Indianapolis, IN 46236
TTY 317/897-3735

- 1976 Toledo Bend, LA
- 1977 Toledo Bend, TX
- 1978 Table Rock, MO
- 1979 Toledo Bend, TX
- 1980 Lake Eufaula, AL
- 1981 Lake Livingston, TX
- 1982 Lake Eufaula, AL
- 1983 Lake Eufaula, OK
- 1984 Kentucky Lake, KY
- 1985 Toledo Bend, TX
- 1986 Bull Shoals, AR
- 1987 Kentucky Lake, KY
- 1988 Truman Lake, MO
- 1989 Lake Barkley, KY
- 1990 Sam Rayburn, TX
- 1991 Kentucky Lake, KY
- 1992 Lake Ouachita, AR
- 1993 West Point Lake, GA
- 1994 Table Rock, MO
- 1995 Lake Okeechobee, FL
- 1996 Truman Lake, MO
- 1997 Western States Region
- 1998 Eastern States Region
- 1999 Central States Region

I am sending you the 3-day total results of our 1992 NBAD tournament in Arkansas. More detailed statistics will follow in the Tackle Box Newsletter this fall. It is going to be difficult for anyone to fill the shoes of Joseph Broz. I am writing to ask if anyone has something they want to write for this fall's newsletter, please send to our Publicity Director Wesley Parsons, PO Box 574, Cheektowaga, NY 14225. It would be nice to see some news from each club.

Also I am writing to ask if your club would like to send a donation for the NDSFR (National Deaf Sport Fishing Records) organization that was led and directed by Joseph Broz. Since this organization was not incorporated, upon the death of Joseph Broz, the family claimed the money that had been designated for this use. The other two staff members, Robert Seremeth and Robert Corbett, have contributed from their own personal funds for this organization, but here is not enough money to continue. Joseph Broz and NDSFR has done a lot to promote NBAD tournaments and deaf fishing records around the country. A small donation of \$126.00 was collected at the NBAD tournament. Since many affiliated club members could not attend the tournament, we are writing to give every one a chance to make a contribution. Please send your check to our treasurer, Jack Stigers, and he will send a total check of all contributions to NDSFR in honor of Joseph Broz. We will let you know the amount we receive. Please have your check to us by August 15, 1992. Thanks again for your response to this and to those who have already contributed.

The 1992 tournament was a success. Many good things happened and now we are ready to start working for the 1993 tournament. For information please contact the General Chairperson, Winfred Larkin.

If you wish additional information about our NBAD organization or tournaments, please contact me.

Your NBAD Secretary,

Elen (Rork) Zook